

SOLID IDEAS MADE IN STEEL

FILTERS CATALOGUE CATALOGO FILTRI

09/2017





ALFA WATER

SOLID IDEAS MADE IN STEEL

| about us

Alfa Water Srl is a dynamic Italian company with a strong track record in the design and manufacturing of all types of manual and automatic screens and filters. We have invested our collective experience in the filtration industry to produce world class solutions and products in stainless steel, super alloys as well as advanced materials.

Alfa Water srl è un'azienda italiana dinamica con una grande esperienza nella progettazione e produzione di filtri manuali e automatici. Abbiamo concentrato la nostra esperienza collettiva nel settore della filtrazione, con soluzioni professionali, utilizzando prodotti in acciaio inox, leghe innovative e materiali dalle avanzate caratteristiche di resistenza.

| our mission

To develop and advance smart filtration solutions and meet our clients' needs and expectations across all industries and applications.

Sviluppiamo soluzioni d'avanguardia nel mondo della filtrazione per soddisfare le esigenze e le aspettative dei nostri clienti in tutti i settori, industriali e non.

Lauro Cendron
CEO



core business

We are committed to deliver solution filtration systems. We have developed a comprehensive standard product range as well as positioned ourselves over the years as technology providers in terms of custom making engineered solutions to meet the application requirements and client's needs. Because filtration technology is not only governed by the laws of physics and mathematics, we have committed to invest our know how and experience into hands on approach to turn problems into solutions.

We appreciate the value of time and money in today's competitive environment, hence our pledge to provide high return on investment as well as return on environment as we are addressing the market needs and specifically the client's requests.

Il nostro obiettivo è fornire soluzioni per i sistemi di filtrazione. Abbiamo sviluppato una completa gamma di prodotti standard, posizionandoci nel corso degli anni come fornitore di tecnologia innovativa, progettando soluzioni tecniche su misura per soddisfare ogni problematica del cliente. Poiché la tecnologia di filtrazione non è solo regolata dalle leggi della fisica e della matematica, ci siamo impegnati a investire la nostra esperienza e know-how per trasformare i problemi in soluzioni. Apprezziamo il valore del tempo e del denaro nell'ambiente competitivo di oggi: da qui il nostro impegno a fornire sistemi con un elevato ritorno sugli investimenti tenendo in massima considerazione l'ambiente.





PRODUCTION

PRODUZIONE

I production

With a strong track record and extensive worldwide installations, Alfa Water S.r.l. is proud to introduce its filtration equipment and solutions product range.

Alfa Water S.r.l. designs, builds and tests the filters in Italy according to the highest standards and internal control procedures.

Our engineers utilize modern techniques of solid modelling to provide robust and well-engineered solutions taking into consideration the chemistry of the process and practical approaches offering minimal operational and maintenance requirements.

Con la comprovata esperienza e le molteplici installazioni in tutto il mondo, Alfa Water S.r.l. è orgogliosa di presentare la sua gamma di prodotti e le soluzioni per la filtrazione.

Alfa Water S.r.l. progetta, costruisce e collauda i filtri in Italia secondo i più elevati standard e le procedure di controllo di qualità.

I nostri ingegneri utilizzano moderne tecniche di modellazione tridimensionale per fornire soluzioni robuste e costruite tenendo conto anche della chimica del processo, con approcci pratici che offrono soluzioni con minimi requisiti operativi e di manutenzione.

I product range

Our product range is ideal for water and wastewater applications as well as industrial such as oil & gas, petrochemical, food industry, mining sector, sea water intake stations and many more.

We also custom design and build filtration systems and batteries to suit the site needs and conditions. We match the most appropriate materials to the application, such as stainless steel, duplex, super duplex, 254SMO, PP and PVDF.

La nostra gamma di prodotti è ideale per il trattamento di acque primarie e reflue, nonché industriale, come l'oil&gas, il petrolchimico, l'industria alimentare, il settore minerario, il trattamento di acqua di mare e molti altri.

Siamo in grado inoltre di progettare sistemi personalizzati, mediante batterie di filtrazione, venendo incontro alle esigenze del cliente e alle condizioni del sito. Abbiniamo i materiali più idonei a ogni applicazione, come l'acciaio inox, duplex, super duplex, 254SMO, PP e PVDF.

SEPARATORS & FILTERS

FILTRI MANUALI E SEPARATORI

AMB
5000÷1000 μm



ABK
5000÷100 μm



AHC
5000÷50 μm

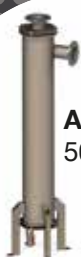

ASF
2000÷25 μm



ABG
200÷1 μm



SELF CLEANING FILTERS

FILTRI AUTOPULENTI

AGT
2000÷25 μm



ABR
2000÷25 μm



ABV
2000÷25 μm

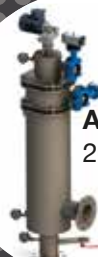

AVC-AVB
1000÷10 μm

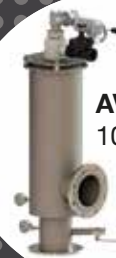

AMA
10÷1 μm



FILTER CARTRIDGE

CARTUCCE FILTRANTI

PS POLYESTER (PETP) FILTERING CARTRIDGE *CARTUCCIA FILTRANTE IN POLIESTERE (PETP)*

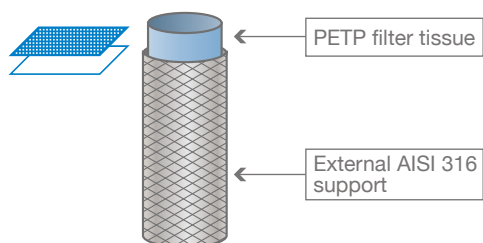

The polyester filtering cartridge is composed of a tubular support screen of AISI 316 Stainless Steel (or Duplex or Titanium) with a polyester (PETP) filter tissue. This solution allows to have a filtration range from 1000 μm to 25 μm .

La cartuccia filtrante in poliestere è composta da una rete tubolare di sostegno in acciaio inox AISI 316 (o Duplex o Titanio) con tessuto filtrante in poliestere (PETP). Questa soluzione permette di avere un intervallo di filtrazione compreso tra 1000 micron e 25 micron.

PSML MULTI-LAYER POLYESTER (PETP) FILTERING CARTRIDGE *CARTUCCIA FILTRANTE MULTISTRATO IN POLIESTERE (PETP)*

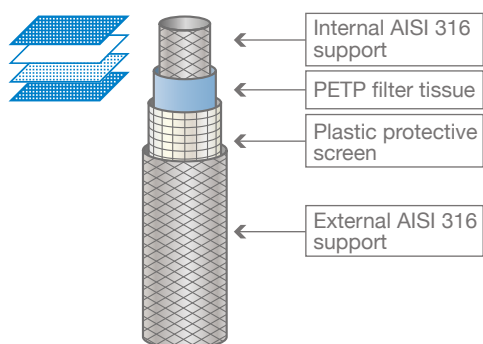

The multi-layer polyester filtering cartridge is composed of polyester (PETP) filter tissue fitted between two tubular support screens of AISI 316 Stainless Steel (or Duplex or Titanium). To mechanically protect the polyester filtering tissue, it is fitted a plastic screen externally to the tissue. This multi-layer system allows to have a filtration range from 1000 μm to 25 μm and allows to protect the filtering tissue from wear caused by passage of suction pads.

La cartuccia filtrante multistrato in poliestere è composta da un tessuto filtrante in poliestere (PETP) montato tra due reti tubolari in acciaio inox AISI 316 (o Duplex o Titanio). Per proteggere meccanicamente il tessuto filtrante in poliestere, viene montato una rete di plastica esternamente al tessuto stesso. Questo sistema multistrato permette di avere un intervallo di filtrazione compreso tra 1000 micron e 25 micron e consente di proteggere il tessuto filtrante dall'usura causata dal passaggio dei pattini aspiranti.

SS-SSML STAINLESS STEEL FILTERING CARTRIDGES *CARTUCCE FILTRANTI IN ACCIAIO INOX*

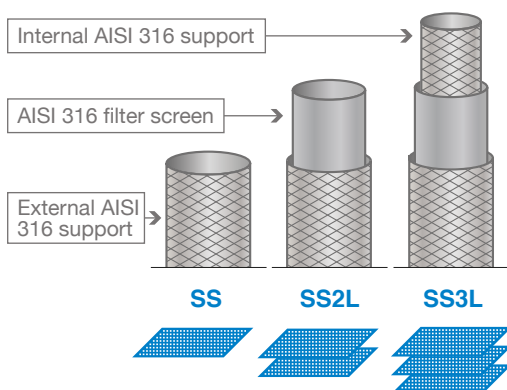

The filtering cartridge of AISI 316 Stainless Steel (or Duplex or Titanium) can be composed of a single tubular perforated sheet, or of a filter screen welded to one or between two tubular support screens, all of AISI 316 Stainless Steel (or Duplex or Titanium).

The multi-layer system allows to have a cartridge with high resistance to wear, strong and durable. This solution allows to have a filtration range from 5000 μm to 50 μm .

La cartuccia filtrante in acciaio inox AISI 316 (o Duplex o Titanio) può essere composta da una singola lamiera forata tubolare, oppure da una rete filtrante saldata su una o tra due reti tubolari, sempre in acciaio inox AISI 316 (o Duplex o Titanio). Il sistema multistrato permette di avere una cartuccia altamente resistente all'usura, robusta e durevole.

Questa soluzione permette di avere un intervallo di filtrazione compreso tra 5000 micron e 50 micron.

PCML PLEATED CARTRIDGE MULTI-LAYER *CARTUCCIA MULTISTRATO PLISSETTATA*

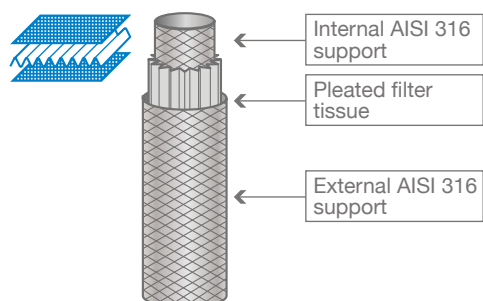

The Patented multi-layer filtering cartridge is obtained with filter tissue enclosed between two layers of polyester protective screen that gives it rigidity. Realized in 2 variants, with or without internal and external AISI 316 Stainless Steel cylinders, it is available with cleaning system with suction pads or spray nozzles and with a filtration range from 100 μm to 1 μm .

La cartuccia filtrante plissettata multistrato brevettata è ottenuta da rete filtrante racchiusa tra due strati di rete protettiva di poliestere che ne conferisce rigidità. Realizzata in 2 varianti, con o senza cilindro interno ed esterno di rete in acciaio inox AISI 316, è utilizzabile per la pulizia con sistema a pattini aspiranti o ugelli spruzzatori. Disponibile con gradi di filtrazione da 100 a 1 micron.

CLEANING TECHNOLOGY

TECNOLOGIE PER LA PULIZIA

VACUUM PATTINI ASPIRANTI



Vacuum are the exclusive cleaning system of the filter cartridge installed into AVC and AGT filters. This is the "suction-scanning" technology, optimized by our research and development department with a new flexibility system of elastic manifolds and a new pad, which allow to have a good contact between the pads and the filtering cartridge, with maximum suction performance. This system ensures cleaning faster, minimum discharge of water and a higher cleaning efficiency with no interruption flow.

I Pattini Aspiranti sono l'esclusivo sistema di pulizia della cartuccia filtrante installato nei filtri AVC e AGT. Si tratta della tecnologia di "suction scanning", ottimizzata dal nostro reparto di ricerca e sviluppo con un nuovo sistema flessibile a collettori elastici e un pattino di nuova generazione, che permette di avere un ottimo contatto tra pattino e cartuccia filtrante, con resa di suzione massima.

Questo sistema garantisce tempi rapidi di pulizia, minimo scarico di acqua e una maggiore efficienza di pulizia senza interruzione di flusso.

BRUSHES SPAZZOLE



Brushes are the cleaning system of the filter cartridge installed into ABR filters. This is composed of stiff brushes, integral with a rotating shaft, that remove not-colloidal particles clogged on the filtering screen. This system is not suitable for water contains soft or colloidal particles.

Le Spazzole sono il sistema di pulizia della cartuccia filtrante installato nei filtri ABR. È composto da spazzole rigide, solidali ad un albero rotante, che rimuovono particelle non-colloidal bloccate sulla rete filtrante. Questo sistema non è adatto per acqua contenente particelle deformabili o colloidal.

VACUUM-BRUSH PATTINI ASPIRANTI CON SPAZZOLE

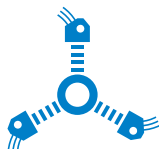

The Vacuum-Brush patented cleaning system is made with the insertion of interchangeable brushes on flexible suction pads. In this way, the brushes allow effective removal of the particles that are more adherent to the suction surface and, at the same time, the suction allows full removal even with inlet pressures less than 2 bar. This cleaning system of the filter cartridge is installed into ABV and AVB filters.

Il sistema di pulizia brevettato Vacuum-Brush è realizzato con l'inserzione di spazzole intercambiabili ai pattini flessibili aspiranti. In questo modo le spazzole permettono una rimozione efficace delle particelle più adese alla superficie aspirante e nel contempo l'aspirazione ne permette la totale rimozione anche con pressioni in ingresso inferiori a 2 bar. Questo sistema di pulizia della cartuccia filtrante è installato nei filtri ABV e AVB.

SPRAY NOZZLES UGELLI SPRUZZATORI

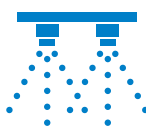















Spray Nozzles are the cleaning system of the filter cartridge installed into AMA filters. This is composed of a series of spray nozzles, which allow to create powerful jets of clean water directed on the filter cartridge, removing all clogged particles, even of colloidal type.

Gli Ugelli Spruzzatori sono il sistema di pulizia della cartuccia filtrante installato nei filtri AMA. È composto da una serie di ugelli spruzzatori che permettono di creare potenti getti di acqua pulita indirizzati sulla cartuccia filtrante, rimuovendo tutte le particelle bloccate, anche di tipo colloidale.

SHAPES

FORME COSTRUTTIVE

FILTERS FILTRI	H	L	Y	S	T	Z
AMB	X	X	X	X		X
ABK	X	X	X	X	X	
AHC	X		X	X	X	X
ASF				X	X	X
ABG	X	X	X	X	X	
AGT	X	X	X	X	X	
ABR				X	X	X
ABV				X	X	X
AVC-AVB				X	X	X
AMA	X	X	X		X	X

PRODUCTS

PRODOTTI



AMB filters



The inline basket strainer designed for pre-filtration of pumps.

- Stainless steel housing and basket
- Reusable baskets
- Easy to install, maintain and clean basket
- Suitable for suction pipes before pumps

Alfa Water AMB filters can support flow rates of up to 350 m³/h (1540 US gpm) with two sizes of screens up to 2200 cm², with basket screens covering the range of filtration degree between 1000 µm to 5000 µm and with different range of inlet/outlet flanged connections between 1"½ and 6".

Il filtro a cestello in linea progettato come pre-filtro per pompe.

- Corpo e cestello in acciaio inox
- Cestello riutilizzabile
- Facilità di installazione, manutenzione e pulizia del cestello
- Adatto per tubazioni in suzione nei sistemi di pompaggio

I filtri Alfa Water AMB possono trattare una portata fino a 350 m³/h (1540 US gpm) con due taglie di cestelli e un'area filtrante fino a 2200 cm², con un range di filtrazione compreso tra 5000 e 1000 µm e con connessioni flangiate di ingresso ed uscita comprese tra 1"½ e 6".



General data - Dati generali

Filter size Taglia filtro	18	22
Inlet/outlet diameter Diametro connessioni IN/OUT	1"½ / 2" / 2"½ / 3" flanged EN 1092-1	4" / 5" / 6" F threaded or Victaulic
Max flow rate (*) Portata massima	100 m ³ /h 440 US gpm	350 m ³ /h 1540 US gpm
Max working pressure Pressione massima	6 bar 87 psi	
Max working temperature Temperatura massima	95 °C 200 °F	

Screen elements - Elementi filtranti

Filter size Taglia filtro	18	22
Screen Area Area filtrante	1800 cm ² 280 in ²	2200 cm ² 340 in ²
Filtration degrees Gradi di filtrazione	5000 / 2000 / 1000 µm	
Screen Type Rete filtrante	Basket: Perforated sheet in Stainless Steel AISI 316 Cestello: lamiera forata in Acciaio inox AISI 316	

Materials - Materiali

Filter Body Corpo filtro	AISI 304 / AISI 316
Cover Coperchio	AISI 304 / AISI 316
Basket Screen Cestello filtrante	AISI 316
Gasket Guarnizioni	EPDM

Head loss - Perdite di carico

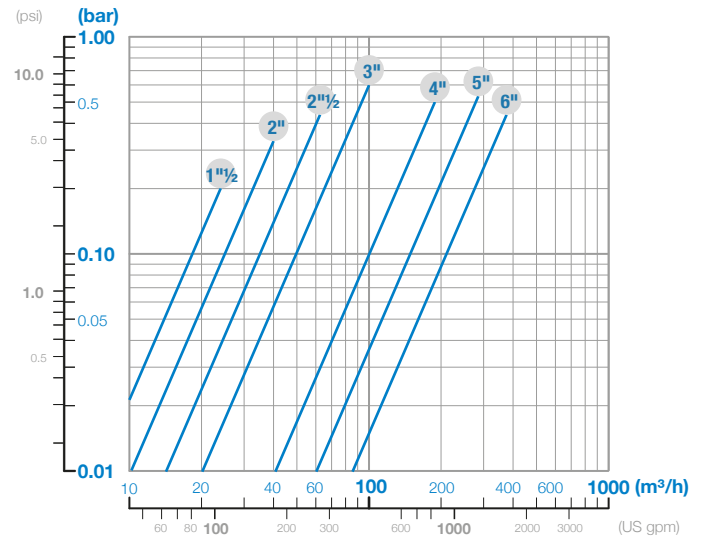

Shape T - Forma T

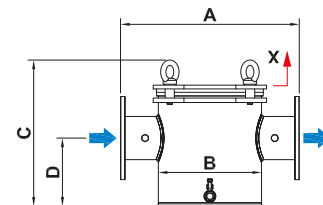

Dimensions - Dimensioni

Filter Model Modello filtro	In/Out Conn.	Drain Conn.	Filter Area [cm ²]	Max Flow rate [m ³ /h]	A [mm]	B [mm]	C [mm]	D [mm]	X [mm]	Weight [Kg]
AMB 18T1½	1 1/2" flg	1/2" thrdF	1800	30	480	273	410	160	400	28
AMB 18T2	2" flg	1/2" thrdF	1800	40	480	273	410	160	400	28
AMB 18T2½	2 1/2" flg	1/2" thrdF	1800	70	480	273	410	160	400	29
AMB 18T3	3" flg	1/2" thrdF	1800	100	480	273	410	160	400	29
AMB 22T4	4" flg	1/2" thrdF	2200	170	480	273	490	230	500	32
AMB 22T5	5" flg	1/2" thrdF	2200	250	480	273	490	230	500	34
AMB 22T6	6" flg	1/2" thrdF	2200	350	480	273	490	230	500	36

ABK filters



The pre-filtration strainer with reusable stainless steel basket designed for long life.

- Stainless steel housing and basket
- Reusable baskets
- No mechanical moving parts
- Easy to install, maintain and clean basket

Alfa Water ABK filters can support flow rates of up to 600 m³/h (2642 US gpm) with five sizes of screens up to 8100 cm², with basket screens covering the range of filtration degree between 100 µm to 5000 µm and with different range of inlet/outlet flanged connections between 2" and 10".

ABK filter is provided with supporting legs, manual drain valve, manual vent valve and pressure gauges.

ABK filters can be equipped with a magnetic kit to capture any particulate metal present in the water.

Il pre-filtro manuale con cestello riutilizzabile in acciaio inox progettato per lunga durata.

- Corpo e cestello in acciaio inox
- Cestelli riutilizzabili
- Nessuna parte meccanica in movimento
- Facile da installare, facile manutenzione e pulizia cestello

I filtri Alfa Water ABK sono in grado di trattare portate fino a 600 m³/h (2642 US gpm) con cinque taglie di cestelli con area filtrante fino a 8100 cm², coprendo un range di filtrazione tra 100 µm e 5000 µm e connessioni flangiate di ingresso e di uscita disponibili da 2" a 10".

I filtri ABK vengono forniti completi di piedi di supporto, valvola manuale di svuotamento, valvola manuale di sfiato e manometri.

I filtri ABK possono essere integrati con un kit di magneti per captare eventuale particolato metallico presente nell'acqua.

General data - Dati generali

Filter size Taglia filtro	16	23	35	55	81
Inlet/outlet diameter Diametro connessioni IN/OUT	2" / 3" / 4" flanged EN 1092-1	3" / 4" / 6" flanged EN 1092-1	4" / 6" / 8" flanged EN 1092-1	4" / 6" / 8" flanged EN 1092-1	6" / 8" / 10" flanged EN 1092-1
Max flow rate (*) Portata massima	100 m ³ /h 440 US gpm	180 m ³ /h 793 US gpm	270 m ³ /h 1189 US gpm	390 m ³ /h 1717 US gpm	600 m ³ /h 2642 US gpm
Max working pressure Pressione massima	10 bar 145psi				
Max working temperature Temperatura massima	80 °C 140 °F				

Screen elements - Elementi filtranti

Filter size Taglia filtro	16	23	35	55	81
Screen Area Area filtrante	1600 cm ² 248 in ²	2300 cm ² 357 in ²	3500 cm ² 543 in ²	5500 cm ² 853 in ²	8100 cm ² 853 in ²
Filtration degrees Gradi di filtrazione	5000 / 2000 / 1000 / 500 / 200 / 100 µm				
Screen types Tipologia elementi filtranti	Basket: Perforated sheet or Multi-layers in Stainless Steel AISI 316 Cestello: lamiera forata o multi strato in Acciaio inox AISI 316				

Materials - Materiali

Filter Body Corpo filtro	AISI 304 / AISI 316 / DUPLEX / 254 SMO
Cover Coperchio	AISI 304 / AISI 316 / DUPLEX / 254 SMO
Basket Screen Cestello filtrante	AISI 316 / DUPLEX / 254 SMO / TITANIUM
Gasket Guarnizioni	EPDM

Head loss - Perdite di carico

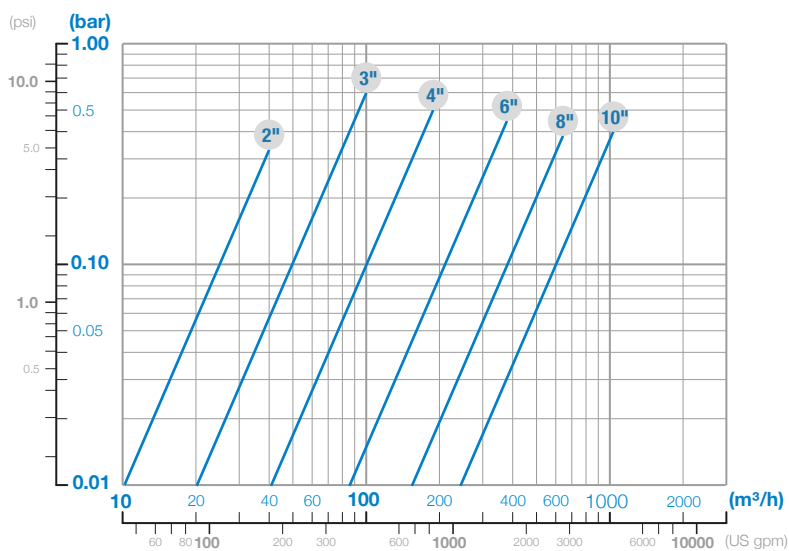

Shape Z - Forma Z

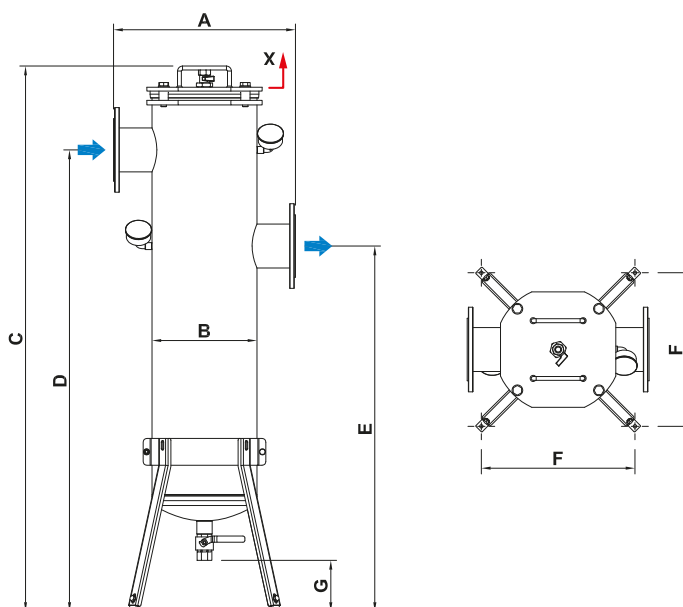

Dimensions - Dimensioni

Filter Model Modello filtro	In/Out Conn.	Drain Conn.	Filter Area [cm ²]	Max Flow rate [m ³ /h]	A [mm]	B [mm]	C [mm]	D [mm]	E [mm]	F [mm]	G [mm]	X [mm]	Weight [Kg]
ABK 16Z2	2" flg	1" thrdF	1600	30	405	206	950 1050	700 800	450 550	350	100 200	400	37
ABK 16Z3	3" flg	1" thrdF	1600	60	405	206	950 1050	700 800	450 550	350	100 200	400	38
ABK 16Z4	4" flg	1" thrdF	1600	100	405	206	950 1050	700 800	450 550	350	100 200	400	39
ABK 23Z3	3" flg	1" thrdF	2300	60	405	206	1150 1250	900 1000	500 600	350	100 200	600	42
ABK 23Z4	4" flg	1" thrdF	2300	100	405	206	1150 1250	900 1000	500 600	350	100 200	600	45
ABK 23Z6	6" flg	1" thrdF	2300	180	405	206	1150 1250	900 1000	500 600	350	100 200	600	48
ABK 35Z4	4" flg	1" thrdF	3500	100	475	273	1200 1300	950 1050	450 550	400	100 200	600	47
ABK 35Z6	6" flg	1" thrdF	3500	220	475	273	1200 1300	950 1050	450 550	400	100 200	600	50
ABK 35Z8	8" flg	1" thrdF	3500	270	475	273	1200 1300	950 1050	450 550	400	100 200	600	55
ABK 55Z4	4" flg	1" thrdF	5500	100	475	273	1500 1600	1250 1350	750 850	400	100 200	900	55
ABK 55Z6	6" flg	1" thrdF	5500	220	475	273	1500 1600	1250 1350	750 850	400	100 200	900	60
ABK 55Z8	8" flg	1" thrdF	5500	390	475	273	1500 1600	1250 1350	750 850	400	100 200	900	65
ABK 81Z6	6" flg	1" thrdF	8100	220	530	324	1600 1700	1300 1400	650 750	450	100 200	900	95
ABK 81Z8	8" flg	1" thrdF	8100	390	530	324	1600 1700	1300 1400	650 750	450	100 200	900	100
ABK 81Z10	10" flg	1" thrdF	8100	600	530	324	1600 1700	1300 1400	650 750	450	100 200	900	105

AHC filters



SHAPES

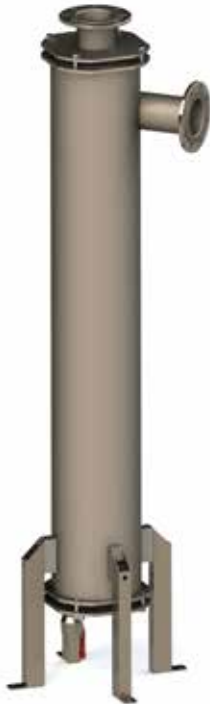

The liquid-solid separator filter with High Efficiency and limited pressure loss.

- High efficiency to remove sand and heavy suspended solids
- No interruption flow
- No filtration screen or internal moving parts
- Zero maintenance
- Very low water loss

Alfa Water AHC filters are centrifugal separator used widely in different industry especially for cooling tower.

They can remove 98% of sand and/or suspended solids size larger than 50 μm . AHC filters support flow rates of up to 2750 m^3/h (12100 US gpm), with different range of inlet/outlet flanged connections between 2" and 20".

AHC filters can be integrated with automatic drain valve.

Available 2 controllers:

- AWC Timer (preset time, IP54)
- AWC Basic controller (preset time and/or manual start, IP54, 4DI, 4AI/DI, 4DO, LCD Display 1.5")

Il filtro separatore di liquido-solido con alta efficienza e limitata perdita di carico.

- Alta efficienza per rimuovere sabbia e pesanti solidi sospesi
- Continuità di flusso
- Nessuna rete filtrante o parti interni in movimento
- Zero manutenzione
- Ridotto volume d'acqua scaricato durante la pulizia

I filtri Alfa Water AHC separatori centrifughi ampiamente utilizzati in diversi campi industriali, soprattutto nelle torri di raffreddamento.

Rimuovono il 98% di sabbia e/o solidi sospesi di dimensione maggiore di 50 μm .

I filtri AHC trattano portate fino a 2750 m^3/h (12100 US gpm), con gamma di connessioni flangiate di ingresso/uscita tra 2" e 20".

I filtri AHC possono essere integrati con valvola di scarico automatica.

Disponibili 2 controller:

- AWC Timer (tempi pre-impostabili, IP54)
- AWC Basic controller (tempi pre-impostabili e/o avvio manuale, IP54, 4DI, 4AI/DI, 4DO, Display LCD 1.5")



General data - Dati generali

Filter Model Modello filtro	AHC L1½	AHC L2	AHC L3	AHC L4	AHC L6
Inlet/outlet diameter Diametro connessioni IN/OUT	1"½ flanged EN 1092-1	2" flanged EN 1092-1	3" flanged EN 1092-1	4" flanged EN 1092-1	6" flanged EN 1092-1
Max flow rate Portata massima	20 m³/h 88 US gpm	30 m³/h 132 US gpm	70 m³/h 308 US gpm	120 m³/h 528 US gpm	280 m³/h 1232 US gpm
Min flow rate Portata minima	10 m³/h 44 US gpm	20 m³/h 88 US gpm	30 m³/h 132 US gpm	60 m³/h 264 US gpm	120 m³/h 528 US gpm
Max working pressure Pressione massima	10 bar 145 psi				
Max working temperature Temperatura massima	60 °C 140 °F				

Filter Model Modello filtro	AHC L8	AHC L10	AHC L12	AHC L16	AHC L20
Inlet/outlet diameter Diametro connessioni IN/OUT	8" flanged EN 1092-1	10" flanged EN 1092-1	12" flanged EN 1092-1	16" flanged EN 1092-1	20" flanged EN 1092-1
Max flow rate Portata massima	450 m³/h 1980 US gpm	750 m³/h 3300 US gpm	1000 m³/h 4400 US gpm	1600 m³/h 7040 US gpm	2750 m³/h 12100 US gpm
Min flow rate Portata minima	250 m³/h 1100 US gpm	400 m³/h 1760 US gpm	600 m³/h 2640 US gpm	900 m³/h 3960 US gpm	1400 m³/h 6160 US gpm
Max working pressure Pressione massima	10 bar 145 psi				
Max working temperature Temperatura massima	60 °C 140 °F				

Head loss - Perdite di carico

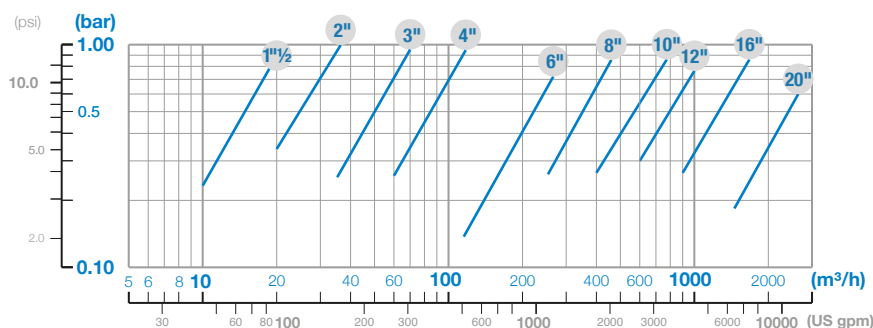

Materials - Materiali

Filter Body Corpo filtro	Painted FeC / AISI 304 / AISI 316
Cover Coperchio	Painted FeC / AISI 304 / AISI 316
Body support Supporto corpo	AISI 304 / AISI 316
Gasket Guarnizioni	EPDM

Shape L - Forma L

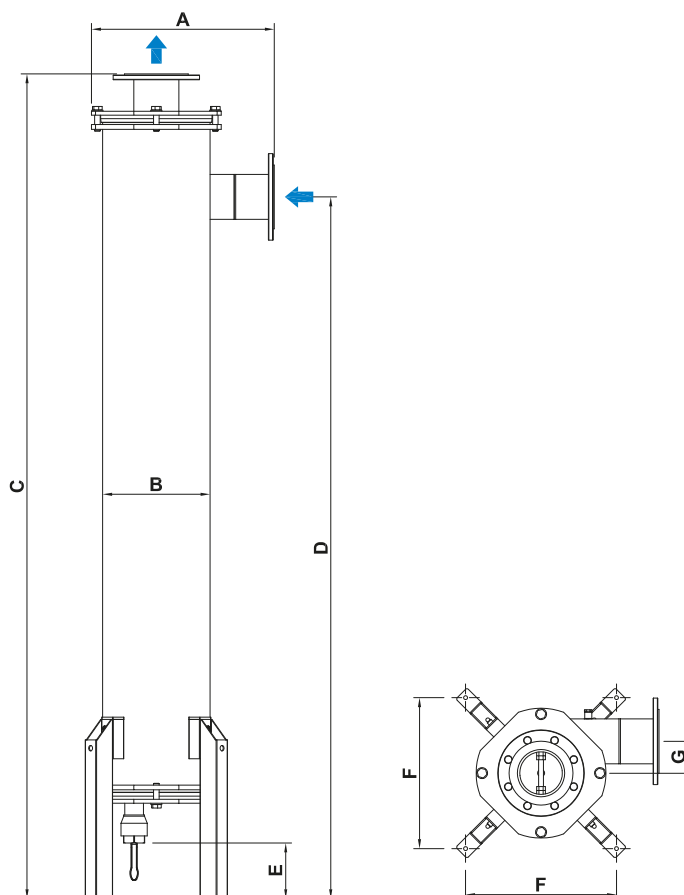

Dimensions - Dimensioni

Filter Model Modello filtro	In/Out Conn.	Drain Conn.	Min Flow rate [m ³ /h]	Max Flow rate [m ³ /h]	A [mm]	B [mm]	C [mm]	D [mm]	E [mm]	F [mm]	G [mm]	Weight [Kg]
AHC L1½	1"½ flg	1" thrdF	10	20	280	140	1200	950	200	280	45	30
AHC L2	2" flg	1" thrdF	20	30	330	168	1400	1150	200	300	55	35
AHC L3	3" flg	1" thrdF	30	70	380	219	1750	1500	250	350	65	55
AHC L4	4" flg	1" thrdF	60	120	460	273	2050	1800	250	400	80	100
AHC L6	6" flg	2" thrdF	120	280	590	406	2400	2100	300	710	120	220
AHC L8	8" flg	2" thrdF	250	450	700	508	2600	2250	150	600	145	290
AHC L10	10" flg	2" thrdF	400	750	800	610	3000	2650	150	705	165	450
AHC L12	12" flg	2" thrdF	600	1000	900	711	3500	3100	150	810	190	550
AHC L16	16" flg	2" thrdF	900	1600	1100	914	4700	4250	150	1020	250	1100
AHC L20	20" flg	2" thrdF	1400	2750	1200	1016	5600	5100	150	1120	250	1900

ASF filters

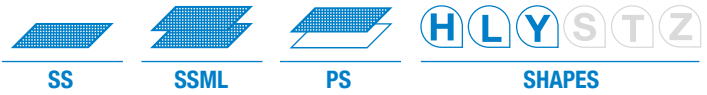

The simple manual screen filter with stainless steel housing: durable, economic and easy to maintain.

The simple manual screen filter with stainless steel housing: durable, economic and easy to maintain.

- Stainless steel housing and filter cartridge
- Interchangeable screens with several filtration degrees
- No mechanical moving parts
- Very durable and economic filtration choice
- Easy to install, maintain and clean/change cartridges
- Low pressure loss

ASF filters can support flow rates of up to 600 m³/h (2642 US gpm) with five sizes of screens up to 8100 cm², with several multi-layers screens covering the range of filtration degree between 2000 and 25 µm and with different range of inlet/outlet connections between 2" and 10".

ASF filters can be equipped with automatic drain valve and magnetic kit to capture any particulate metal present in the water.

Available 2 controllers:

- AWC Timer (preset time, IP54)
- AWC Basic controller (preset time and/or manual start, IP54, 4DI, 4AI/DI, 4DO, LCD Display 1.5")



Il filtro a rete a pulizia manuale con corpo in acciaio inox: duraturo, economico e di semplice manutenzione.

- *Corpo e cartuccia filtrante in acciaio inox*
- *Reti intercambiabili con ampia gamma di gradi di filtrazione*
- *Nessuna parte meccanica in movimento*
- *Molto economico e di notevole durata*
- *Facilità di installazione, manutenzione e pulizia/sostituzione della cartuccia*
- *Perdite di carico minime*

I filtri ASF riescono a trattare una porta fino a 600 m³/h (2642 US gpm) con cinque taglie di cartucce filtranti multistrato e un'area filtrante fino a 8100 cm², con un ampio range di filtrazione da 2000 a 25 µm e con connessioni flangiate di ingresso ed uscita comprese tra 2" e 10".

I filtri ASF possono essere integrati con valvola automatica di svuotamento e kit di magneti per captare eventuale particolato metallico presente nell'acqua.

Disponibili 2 controller:

- AWC Timer (tempi pre-impostabili, IP54)
- AWC Basic controller (differenza di pressione e/o tempi pre-impostabili e/o avvio manuale, IP54, 4DI, 4AI/DI, 4DO, Display LCD 1.5")

General data - Dati generali

Filter size Taglia filtro	16	23	35	55	81
Inlet/outlet diameter Diametro connessioni IN/OUT	2" / 3" / 4" flanged EN 1092-1	3" / 4" / 6" flanged EN 1092-1	4" / 6" / 8" flanged EN 1092-1	4" / 6" / 8" flanged EN 1092-1	6" / 8" / 10" flanged EN 1092-1
Max flow rate Portata massima	100 m ³ /h 440 US gpm	180 m ³ /h 793 US gpm	270 m ³ /h 1189 US gpm	390 m ³ /h 1717 US gpm	600 m ³ /h 2642 US gpm
Max working pressure Pressione massima	10 bar 145 psi				
Max working temperature Temperatura massima	80 °C 140 °F				

Screen elements - Elementi filtranti

Screen Area Area filtrante	1600 cm ² 248 in ²	2300 cm ² 357 in ²	3500 cm ² 543 in ²	5500 cm ² 853 in ²	8100 cm ² 1256 in ²
Filtration degrees Gradi di filtrazione	2000 / 1000 / 400 / 200 / 100 / 80 / 53 / 25 µm				
Screen types Tipologia elementi filtranti	Screens: Stainless Steel AISI 316 or Multi-layers SS AISI316 + PETP (Polyester) Reti: Acciaio inox AISI 316 oppure multistrato Inox AISI316 + Poliestere PETP				

Materials - Materiali

Filter Body Corpo filtro	AISI 304 / AISI 316 / DUPLEX / 254 SMO
Cover Coperchio	AISI 304 / AISI 316 / DUPLEX / 254 SMO
Screen support Supporto rete	AISI 304 / AISI 316 / DUPLEX / 254 SMO
Gasket Guarnizioni	EPDM

Head loss - Perdite di carico

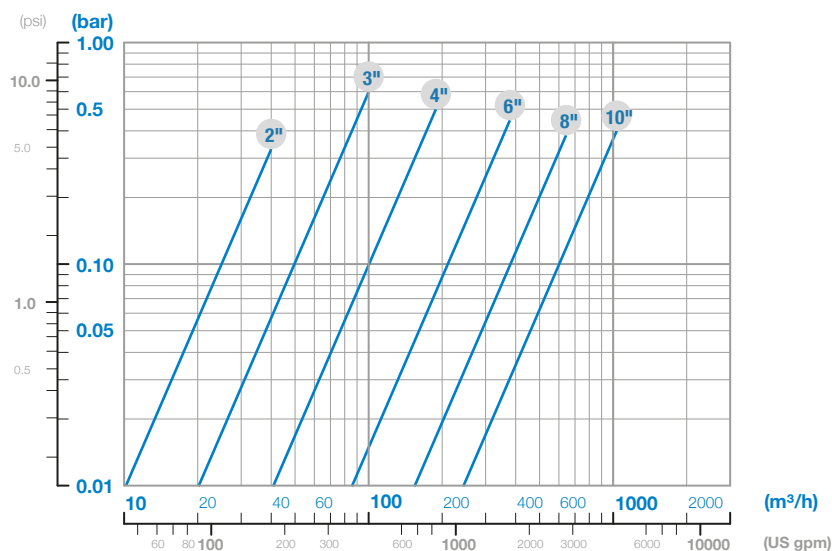

Shape H - Forma H

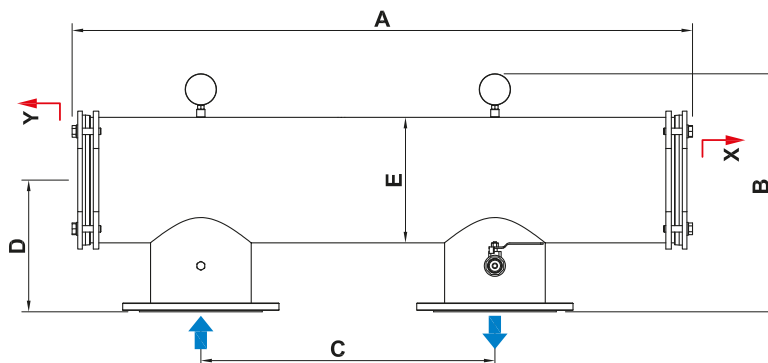

Dimensions - Dimensioni

Filter Model Modello filtro	In/Out Conn.	Drain Conn.	Filter Area [cm ²]	Max Flow rate [m ³ /h]	A [mm]	B [mm]	C [mm]	D [mm]	E [mm]	X [mm]	Y [mm]	Weight [Kg]
ASF 16H2	2" flg	1" thrdF	1600	30	935	410	450	215	206	400	600	24
ASF 16H3	3" flg	1" thrdF	1600	60	935	410	450	215	206	400	600	26
ASF 16H4	4" flg	1" thrdF	1600	100	935	410	450	215	206	400	600	28
ASF 23H3	3" flg	1" thrdF	2300	60	935	410	450	215	206	600	400	27
ASF 23H4	4" flg	1" thrdF	2300	100	935	410	450	215	206	600	400	29
ASF 23H6	6" flg	1" thrdF	2300	180	935	410	450	215	206	600	400	33
ASF 35H4	4" flg	1" thrdF	3500	100	1395	480	640	285	237	600	900	61
ASF 35H6	6" flg	1" thrdF	3500	220	1395	480	640	285	237	600	900	65
ASF 35H8	8" flg	1" thrdF	3500	270	1395	480	640	285	237	600	900	71
ASF 55H4	4" flg	1" thrdF	5500	100	1395	480	640	285	273	900	600	62
ASF 55H6	6" flg	1" thrdF	5500	220	1395	480	640	285	273	900	600	66
ASF 55H8	8" flg	1" thrdF	5500	390	1395	480	640	285	273	900	600	72
ASF 81H6	6" flg	1" thrdF	8100	220	1395	530	640	315	324	900	600	112
ASF 81H8	8" flg	1" thrdF	8100	390	1395	530	640	315	324	900	600	118
ASF 81H10	10" flg	1" thrdF	8100	600	1395	530	640	315	324	900	600	128

Shape L - Forma L

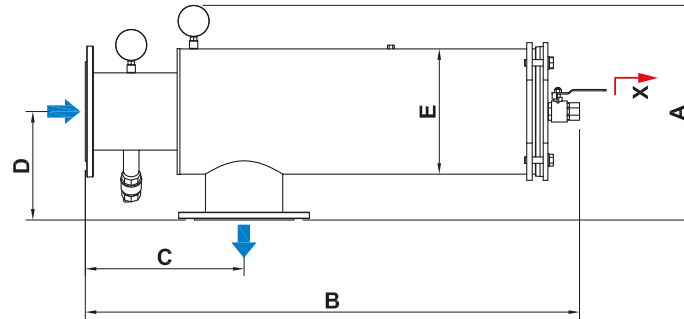

Dimensions - Dimensioni

Filter Model Modello filtro	In/Out Conn.	Drain Conn.	Filter Area [cm ²]	Max Flow rate [m ³ /h]	A [mm]	B [mm]	C [mm]	D [mm]	E [mm]	X [mm]	Weight [Kg]
ASF 16L2	2" flg	1" thrdF	1600	30	400	645	295	203	206	400	22
ASF 16L3	3" flg	1" thrdF	1600	60	400	645	295	203	206	400	23
ASF 16L4	4" flg	1" thrdF	1600	100	400	645	295	203	206	400	24
ASF 23L3	3" flg	1" thrdF	2300	60	400	865	295	203	206	600	25
ASF 23L4	4" flg	1" thrdF	2300	100	400	865	295	203	206	600	26
ASF 23L6	6" flg	1" thrdF	2300	180	400	865	295	203	206	600	27
ASF 35L4	4" flg	1" thrdF	3500	100	470	865	345	236	273	600	33
ASF 35L6	6" flg	1" thrdF	3500	220	470	865	345	236	273	600	36
ASF 35L8	8" flg	1" thrdF	3500	270	470	865	345	236	273	600	41
ASF 55L4	4" flg	1" thrdF	5500	100	470	1350	345	236	273	900	42
ASF 55L6	6" flg	1" thrdF	5500	220	470	1350	345	236	273	900	47
ASF 55L8	8" flg	1" thrdF	5500	390	470	1350	345	236	273	900	52
ASF 81L6	6" flg	1" thrdF	8100	220	620	1350	395	315	324	900	78
ASF 81L8	8" flg	1" thrdF	8100	390	620	1350	395	315	324	900	83
ASF 81L10	10" flg	1" thrdF	8100	600	620	1350	395	315	324	900	88

Shape Y - Forma Y

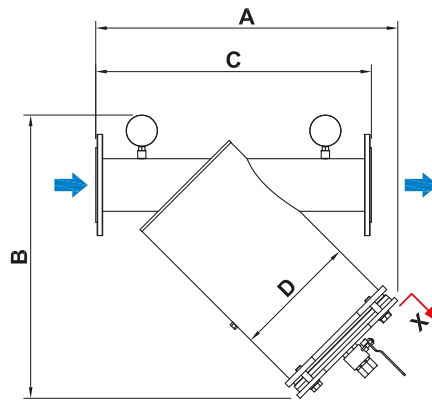

Dimensions - Dimensioni

Filter Model Modello filtro	In/Out Conn.	Drain Conn.	Filter Area [cm ²]	Max Flow rate [m ³ /h]	A [mm]	B [mm]	C [mm]	D [mm]	X [mm]	Weight [Kg]
ASF 16Y2	2" flg	1" thrdF	1600	30	515	435	395	206	400	20
ASF 16Y3	3" flg	1" thrdF	1600	60	535	455	450	206	400	21
ASF 16Y4	4" flg	1" thrdF	1600	100	575	495	550	206	400	22
ASF 23Y3	3" flg	1" thrdF	2300	60	655	595	450	206	600	22
ASF 23Y4	4" flg	1" thrdF	2300	100	695	615	550	206	600	25
ASF 35Y4	4" flg	1" thrdF	3500	100	705	635	600	273	600	34
ASF 35Y6	6" flg	1" thrdF	3500	220	775	665	745	273	600	37
ASF 55Y4	4" flg	1" thrdF	5500	100	975	865	600	273	900	42
ASF 55Y6	6" flg	1" thrdF	5500	220	975	895	745	273	900	47

ABG filters



SHAPES

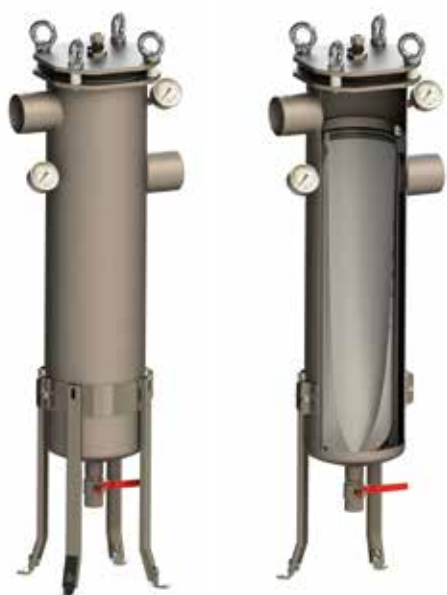

The bag filter with stainless housing and internal bag for heavy duty applications.

- Stainless steel housing
- Interchangeable bags with several filtration degrees
- No mechanical moving parts
- Easy to install, maintain and change bags
- Filtration degree goes down to 1 μm

Alfa Water ABG filters support flow rates of up to 70 m³/h (308 US gpm), with two sizes of bag up to 4500 cm² covering the range of filtration degree between 200 and 1 μm and with inlet/outlet connections sizes: 2" and 3".

ABG filter is provided with supporting legs, manual drain valve, manual vent valve and pressure gauges.

ABG filters can be equipped with a magnetic kit to capture any particulate metal present in the water.

Il filtro a sacco con corpo in acciaio inox e sacco interno per impieghi gravosi.

- Corpo in acciaio inox
- Sacchi intercambiabili con molteplici gradi di filtrazione
- Nessuna parte meccanica in movimento
- Facile da installare, facile manutenzione e sostituzione del sacco filtrante
- Grado di filtrazione minimo fino a 1 μm

I filtri Alfa Water ABG sono in grado di trattare portate fino a 70 m³/h (308 US gpm), con due dimensioni di sacco con area filtrante fino a 4500 cm², coprendo un range di filtrazione tra 200 e 1 μm e con connessioni d'ingresso ed uscita da 2" o 3".

I filtri ABG vengono forniti completi di piedi di supporto, valvola manuale di svuotamento, valvola manuale di sfiato e manometri.

I filtri ABG possono essere integrati con un kit di magneti per captare eventuale particolato metallico presente nell'acqua.

General data - Dati generali

Filter size Taglia filtro	24	45
Inlet/outlet diameter Diametro connessioni IN/OUT	2" / 3" F threaded or Victaulic	2" / 3" F threaded or Victaulic
Max flow rate (*) Portata massima	38 m ³ /h 167 US gpm	70 m ³ /h 308 US gpm
Max working pressure Pressione massima	10 bar 145 psi	
Filter bag replacement Δp sostituzione sacco	1.7 bar (@ 25 °C) 25 psi (@ 77 ° F)	
Filter bag max allowable Δp Max Δp sacco filtrante	3.5 bar (@ 25°C) 51 psi (@ 77 ° F)	
Max working temperature Temperatura massima	80 °C 176 °F	

(*) Flow rate are referred to water with temperature of 20°C and NTU<1 – Le portate sono riferite ad acqua a 20°C and NTU < 1

Screen elements - Elementi filtranti

Filter size Taglia filtro	24	45
Screen Area Area filtrante	2400 cm ² 372 in ²	4500 cm ² 697 in ²
Filter bag dimension Dimensioni sacco filtrante	Ø178 x L420 mm	Ø178 x L810 mm
Filtration degrees Gradi di filtrazione	200 / 100 / 50 / 25 / 10 / 5 / 1 µm	
Bag Filter Sacco filtrante	Polyester Poliestere	

Materials - Materiali

Filter Body Corpo filtro	AISI 304 / AISI 316
Cover Coperchio	AISI 304 / AISI 316
Body support Supporto corpo	AISI 304
Bag support Supporto sacco	AISI 316
Gasket Guarnizioni	EPDM

Shape Z - Forma Z

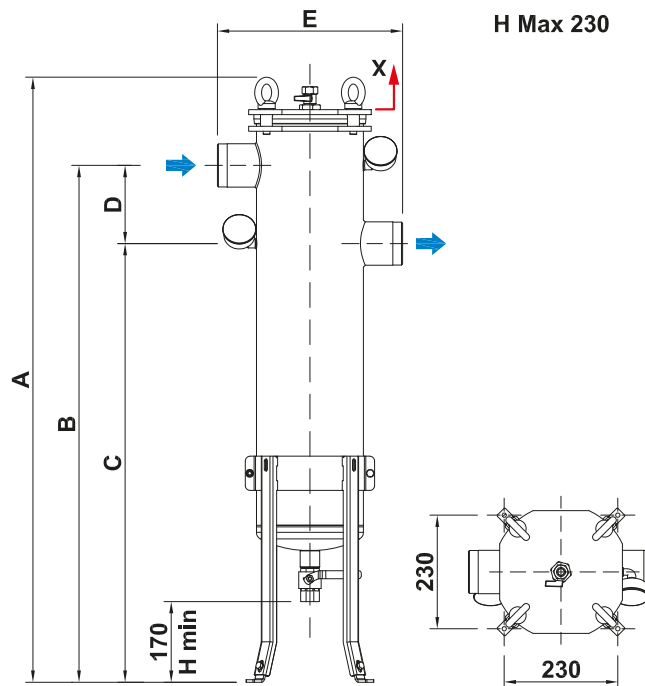

Head loss - Perdite di carico

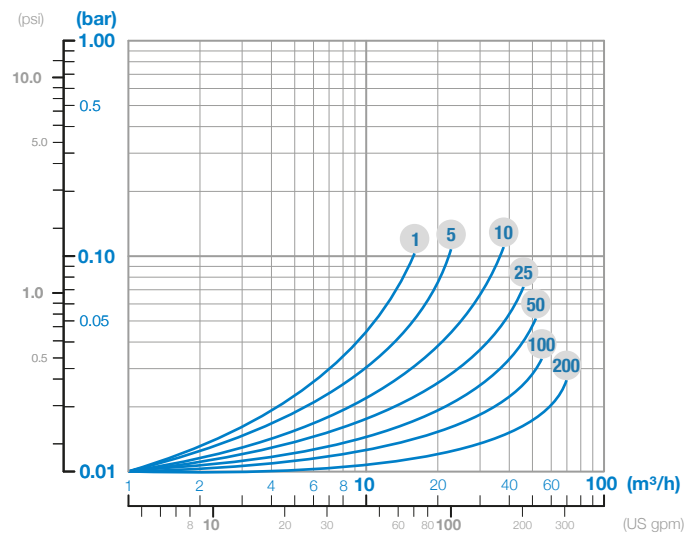

Dimensions - Dimensioni

Filter Model Modello filtro	In/Out Conn.	Drain Conn.	Filter Area [cm ²]	Max Flow rate [m ³ /h]	A [mm]	B [mm]	C [mm]	D [mm]	E [mm]	X [mm]	Weight [Kg]
ABG 24Z2	2" thrdM	1" thrdF	2400	30	860 920	670 730	510 570	160	380	500	25
ABG 24Z3	3" thrdM	1" thrdF	2400	40	860 920	670 730	510 570	160	380	500	25
ABG 45Z2	2" thrdM	1" thrdF	4500	30	1330 1390	1060 1120	900 960	160	380	900	32
ABG 45Z3	3" thrdM	1" thrdF	4500	60	1330 1390	1060 1120	900 960	160	380	900	32

AGT filters



The automatic self-cleaning filter for filtration of high flow rate with continuous filtration process.

- Multi-cartridge solution
- Multi-layers screens with several filtration degrees
- No interruption flow during the cleaning cycle
- Minimum cleaning water consumption
- Very reliable and efficient cleaning mechanism with suction scanner
- Easy to change cartridges or filtration degree

Alfa Water AGT filters are automatic filters with suction scanning self-cleaning mechanism, driven by electric motors, suitable for high flow rates.

Thanks to flexible mechanism of scanner, ensuring adherence to the screen, this filter has high cleaning efficiency.

They have different angles configuration for installation (In-Out axis: 0°, 90°, 180° and 270°). AGT filters can support flow rates of up to 1600 m³/h (7044 US gpm) with five sizes of screens up to 22000 cm², with several multi-layers screens covering the range of filtration degree between 1000 and 25 µm and with different range of inlet/outlet flanged connections between 10" and 20".

Available 2 controllers:

- WC Basic controller (differential pressure and/or preset time and/or manual start, IP54, 4DI, 4AI/DI, 4DO, LCD Display 1.5")
- AWC Full controller (as AWC Basic but it can be integrated into existing systems, no need monitoring, IP54, 4DI, 4AI/DI, 4PowerDO + 3DO, LCD Display 3.5")



Filtro automatico autopulente per alte portate che garantisce la continuità di flusso.

- Soluzione a multi-cartucce
- Reti multistrato con ampio range di filtrazione
- Continuità di flusso durante il ciclo di pulizia
- Minimo consumo d'acqua di pulizia
- Meccanismo di pulizia efficiente e molto affidabile con "suction scanner"
- Facile sostituzione delle cartucce o del grado di filtrazione

I filtri Alfa Water AGT sono filtri automatici dotati di meccanismo autopulente "suction scanning", messo in rotazione da un motore elettrico, adatti alle alte portate.

Grazie al meccanismo di scanner flessibile, che assicura aderenza alla cartuccia filtrante, questo filtro ha un'elevata efficienza di pulizia.

Possono essere installati con diversi angoli tra le connessioni di ingresso e uscita (0°, 90°, 180° e 270°).

I filtri AGT possono trattare una portata fino a 1600 m³/h (7044 US gpm) con cinque taglie di cartucce con area filtrante fino a 22000 cm², con molteplici cartucce multistrato con range di filtrazione compreso tra 1000 e 25 µm e con connessioni flangiate in ingresso e in uscita comprese tra 10" e 20".

Disponibili 2 controller:

- AWC Basic controller (differenza di pressione e/o tempi pre-impostabili e/o avvio manuale, IP54, 4DI, 4AI/DI, 4DO, Display LCD 1.5")
- AWC Full controller (stesse caratteristiche di AWC Basic con possibilità di integrazione con sistemi esistenti, nessuna necessità di monitoraggio, IP54, 4DI, 4AI/DI, 4PowerDO + 3DO, Display LCD 3.5")

General data - Dati generali

Filter size Taglia filtro	165	220
Inlet/outlet diameter Diametro connessioni IN/OUT	10" / 12" / 14" flanged EN 1092-1	12" / 16" / 20" flanged EN 1092-1
Max flow rate (*) Portata massima	1200 m ³ /h 5283 US gpm	1600 m ³ /h 7044 US gpm
Min working pressure Pressione minima	2.5 bar 36.25 psi	
Max working pressure Pressione massima	10 bar 145 psi	
Max working temperature Temperatura massima	80 °C 176 °F	

Screen elements - Elementi filtranti

Screen Area Area filtrante	16500 cm ² 2558 in ²	22000 cm ² 3410 in ²
Filtration degrees Gradi di filtrazione	2000 / 1000 / 800 / 500 / 400 / 200 / 100 / 50 / 25 µm	
Screen types Tipologia elementi filtranti	Multi-layers screens: SS AISI 316 (or Duplex or Titanium) or SS AISI 316 (or Duplex or Titanium) + PETP (Polyester) Rete multistrato: Inox AISI 316 (o Duplex o Titanio) oppure AISI 316 (o Duplex o Titanio) + Poliestere PETP	

Cleaning Cycle - Ciclo di pulizia

Cleaning cycle time Durata ciclo di pulizia	48 - 60 sec	64 - 80 sec
Min cleaning flow rate Portata minima di pulizia	15 m ³ /h 40 US gpm	15 m ³ /h 66 US gpm
Rinse water discharged Acqua di pulizia scaricata	210 L	280 L
Drain valve Valvola di scarico	3 x 2" flanged EN 1092-1	4 x 2" flanged EN 1092-1
Cleaning criteria Avvio ciclo di pulizia	Differential pressure (0.6 bar), time intervals and manual operation Pressione differenziale (0.6 bar), intervalli di tempo, manualmente	

Head loss - Perdite di carico

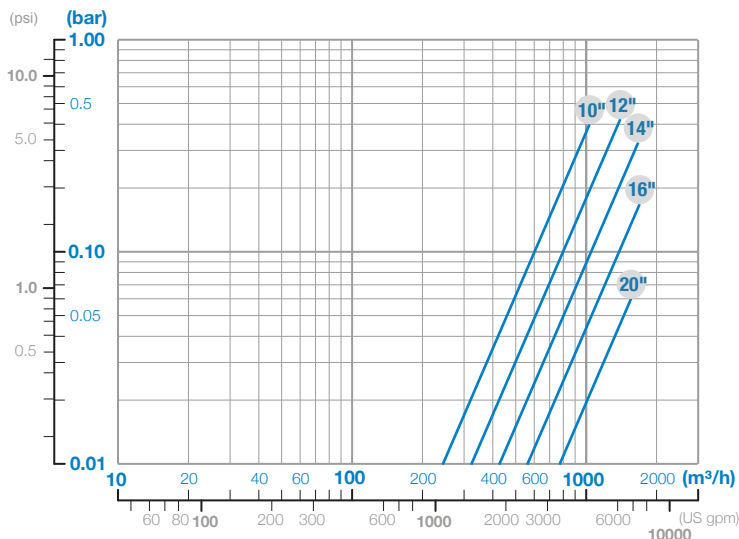

Electrical data - Dati elettrici

Filter size Taglia filtro	165	220
Supply voltage Tensione di alimentazione	230 Vac 1-phase 50/60 Hz Optional: 400 Vac 3-phases 50/60 Hz	
Control voltage Voltaggio di comando	24 Vdc	
Electric motor power Potenza elettrica motore	3 x 75 W	4 x 75 W

Materials - Materiali

Filter Body Corpo filtro	AISI 304 / AISI 316 / DUPLEX / 254 SMO
Cover Coperchio	AISI 304 / AISI 316 / DUPLEX / 254 SMO
Screen support Supporto rete	AISI 316 / DUPLEX / 254 SMO / TITANIUM
Gasket Guarnizioni	EPDM

ABR filters



The automatic self-cleaning filter with brushes for the prefiltration of surface and process water containing not-colloidal suspended solids.

- Stainless steel housing and filter cartridge
- Interchangeable screens with several filtration degrees
- Economic and robust choice for automation of filtration
- Low inlet pressure requested

Alfa Water ABR filters are automatic filters with a set of brushes mounted on a rotating shaft, driven by an electric motor.

ABR filters can support flow rates of up to 390 m³/h (1717 US gpm) with four sizes of screens up to 5500 cm², with several screens covering the range of filtration degree between 2000 and 25 µm and with different range of inlet/outlet connections between 2" and 6".

Available 2 controllers:

- AWC Basic controller (differential pressure and/or preset time and/or manual start, IP54, 4DI, 4AI/DI, 4DO, LCD Display 1.5")
- AWC Full controller (as AWC Basic but it can be integrated into existing systems, no need monitoring, IP54, 4DI, 4AI/DI, 4PowerDO + 3DO, LCD Display 3.5")



Il filtro automatico autopulente con spazzole per la prefiltrazione di acqua di processo e di superficie contenente solidi sospesi non colloidali.

- Corpo e cartuccia filtrante in acciaio inox
- Reti intercambiabili con ampio range di filtrazione
- Scelta economica e robusta per filtrazione automatica
- Richiesta bassa pressione in ingresso

I filtri Alfa Water ABR sono filtri automatici dotati di spazzole montate su un albero messo in rotazione da un motore elettrico.

I filtri ABR sono in grado di trattare portate fino a 390 m³/h (1717 US gpm) con quattro taglie di cartucce con area filtrante fino a 5.500 cm², con range di filtrazione compreso tra 2000 e i 25 µm e connessioni flangiata in ingresso e in uscita comprese tra 2" e 6".

Disponibili 2 controller:

- AWC Basic controller (differenza di pressione e/o tempi pre-impostabili e/o avvio manuale, IP54, 4DI, 4AI/DI, 4DO, Display LCD 1.5")
- AWC Full controller (stesse caratteristiche di AWC Basic con possibilità di integrazione con sistemi esistenti, nessuna necessità di monitoraggio, IP54, 4DI, 4AI/DI, 4PowerDO + 3DO, Display LCD 3.5")

General data - Dati generali

Filter size Taglia filtro	16	23	35	55
Inlet/outlet diameter Diametro connessioni IN/OUT	2" / 3" / 4" flanged EN 1092-1	3" / 4" flanged EN 1092-1	4" / 6" flanged EN 1092-1	4" / 6" flanged EN 1092-1
Max flow rate Portata massima	100 m ³ /h 440 US gpm	180 m ³ /h 793 US gpm	270 m ³ /h 1189 US gpm	390 m ³ /h 1717 US gpm
Min working pressure Pressione minima	1.5 bar 22 psi			
Max working pressure Pressione massima	10 bar 145 psi			
Max working temperature Temperatura massima	60 °C 140 °F			

Screen elements - Elementi filtranti

Screen Area Area filtrante	1600 cm ² 233 in ²	2300 cm ² 341 in ²	3500 cm ² 512 in ²	5500 cm ² 837 in ²
Filtration degrees Gradi di filtrazione	2000 / 1000 / 800 / 500 / 400 / 200 / 100 / 50 / 25 µm			
Screen Type Rete filtrante	Screens: Stainless Steel AISI 316 or Multi-layers SS AISI316 + PETP (Polyester) Reti: Acciaio inox AISI 316 oppure multistrato Inox AISI316 + Poliestere PETP			

Cleaning Cycle - Ciclo di pulizia

Cleaning cycle time Durata ciclo di pulizia	20 - 30 sec			
Min cleaning flow rate Portata minima di pulizia	5 m ³ /h 22 US gpm	7 m ³ /h 31 US gpm	7 m ³ /h 31 US gpm	10 m ³ /h 44 US gpm
Rinse water discharged Acqua di pulizia scaricata	30 L	40 L	40 L	60 L
Drain valve Valvola di scarico	1"½ F threaded			
Cleaning criteria Avvio ciclo di pulizia	Differential pressure (0.6 bar), time intervals and manual operation Pressione differenziale (0.6 bar), intervalli di tempo, manualmente			

Electrical data - Dati elettrici

Supply voltage Tensione di alimentazione	230 Vac 1-phase 50/60 Hz Optional: 400 Vac 3-phases 50/60 Hz
Control voltage Votaggio di comando	24 Vdc
Electric motor power Potenza elettrica motore	75 W
Electric motor consumption Consumo motore elettrico	4,8 A

Materials - Materiali

Filter Body Corpo filtro	AISI 304 / AISI 316
Cover Coperchio	AISI 304 / AISI 316
Screen support Supporto rete	AISI 304 / AISI 316
Gasket Guarnizioni	EPDM

Head loss - Perdite di carico

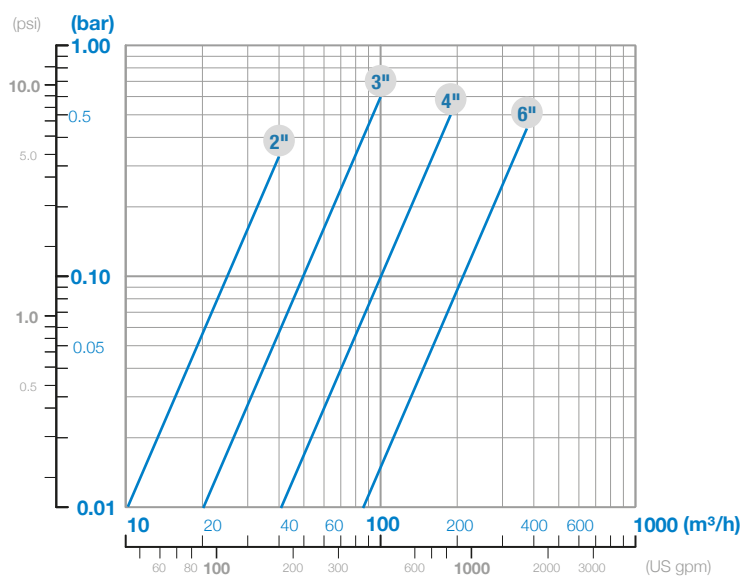

Shape Y - Forma Y

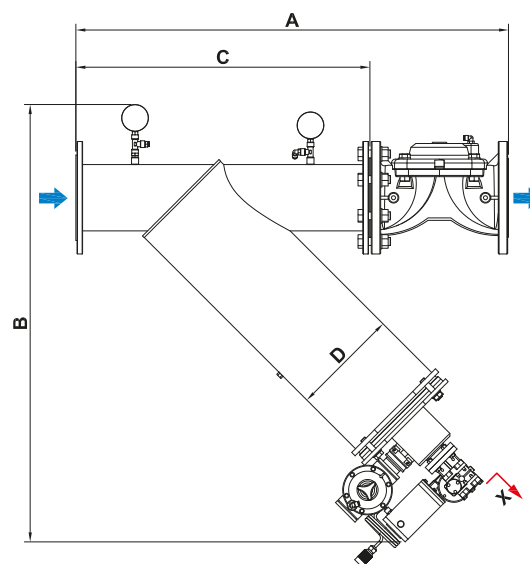

Dimensions - Dimensioni

Filter Model Modello filtro	In/Out Conn.	Drain Conn.	Filter Area [cm ²]	Max Flow rate [m ³ /h]	A [mm]	B [mm]	C [mm]	D [mm]	X [mm]	Weight [Kg]
ABR 16Y2	2" flg	1"½" thrdF	1600	30	550	745	395	206	400	38
ABR 16Y3	3" flg	1"½" thrdF	1600	60	650	765	450	206	400	50
ABR 16Y4	4" flg	1"½" thrdF	1600	100	850	775	550	206	400	53
ABR 23Y3	3" flg	1"½" thrdF	2300	60	650	875	450	206	600	51
ABR 23Y4	4" flg	1"½" thrdF	2300	100	850	885	550	206	600	56
ABR 35Y4	4" flg	1"½" thrdF	3500	100	900	895	600	273	600	65
ABR 35Y6	6" flg	1"½" thrdF	3500	220	1100	925	745	273	600	93
ABR 55Y4	4" flg	1"½" thrdF	5500	100	900	1095	600	273	900	73
ABR 55Y6	6" flg	1"½" thrdF	5500	220	1100	1125	745	273	900	103

AVC-AVB filters



PSML

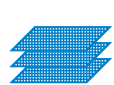

SSML



PCML



NO STOP FLOW



Vacuum-Brush



SHAPES

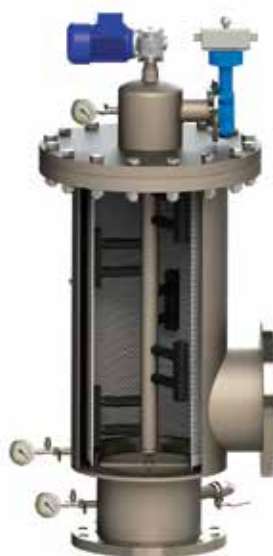

The automatic self-cleaning filter with high efficiency due to the continuous filtration process and the low cleaning water consumption.

- Multi-layers screens with several filtration degrees
- No interruption flow during the cleaning cycle
- Minimum cleaning water consumption
- Very reliable and efficient cleaning mechanism with suction scanner

Alfa Water AVC filters are automatic filters with suction scanning self-cleaning mechanism, driven by an electric motor. AVB filters are fitted with suction pads with brushes, which ensure excellent cleaning even with reduced pressure at the filter inlet. Both filters, thanks to the flexible scanner mechanism, ensuring adherence to the screen, have high cleaning efficiency.

AVC filters can support flow rates of up to 1400 m³/h (6164 US gpm) with seven sizes of screens up to 19800 cm², with several multi-layers screens covering the range of filtration degree between 2000 and 25 µm and with different range of inlet/outlet flanged connections between 2" and 16".

Available 2 controllers:

- AWC Basic controller (differential pressure and/or preset time and/or manual start, IP54, 4DI, 4AI/DI, 4DO, LCD Display 1.5")
- AWC Full controller (as AWC Basic but it can be integrated into existing systems, no need monitoring, IP54, 4DI, 4AI/DI, 4PowerDO + 3DO, LCD Display 3.5")

Filtro automatico autopulente ad alta efficienza che garantisce la continuità di flusso e ridotti consumi d'acqua in fase di lavaggio.

- Reti multistrato con ampio range di filtrazione
- Continuità di flusso durante il ciclo di pulizia
- Minimo consumo d'acqua di pulizia
- Meccanismo di pulizia efficiente e molto affidabile con "suction scanner"

I filtri Alfa Water AVC sono filtri automatici dotati di meccanismo autopulente "suction scanning", messo in rotazione da un motore elettrico. I filtri AVB montano pattini aspiranti dotati di spazzole, che assicurano un'ottima pulizia anche con pressioni ridotte in ingresso al filtro. Entrambi i filtri, grazie al meccanismo di scanner flessibile, che assicura aderenza alla cartuccia filtrante, hanno un'elevata efficienza di pulizia. I filtri AVC possono trattare una portata fino a 1400 m³/h (6164 US gpm) con sette taglie di cartucce con area filtrante fino a 19800 cm², con molteplici cartucce multistrato con range di filtrazione compreso tra 2000 e 25 µm e con connessioni flangiate in ingresso e in uscita comprese tra 2" e 16".

Disponibili 2 controller:

- AWC Basic controller (differenza di pressione e/o tempi pre-impostabili e/o avvio manuale, IP54, 4DI, 4AI/DI, 4DO, Display LCD 1.5")
- AWC Full controller (stesse caratteristiche di AWC Basic con possibilità di integrazione con sistemi esistenti, nessuna necessità di monitoraggio, IP54, 4DI, 4AI/DI, 4PowerDO + 3DO, Display LCD 3.5")



AVC

Suction scanner:
Pin > 2.5 bar



AVB

Suction scanner with
brushes: Pin > 1.5 bar

General data - Dati generali

Filter size Taglia filtro	16	23	35	55
Inlet/outlet diameter Diametro connessioni IN/OUT	2" / 3" / 4" flanged EN 1092-1	3" / 4" / 6" flanged EN 1092-1	4" / 6" / 8" flanged EN 1092-1	4" / 6" / 8" flanged EN 1092-1
Max flow rate (*) Portata massima	100 m ³ /h 440 US gpm	180 m ³ /h 793 US gpm	270 m ³ /h 1189 US gpm	390 m ³ /h 1717 US gpm
Min working pressure Pressione minima	2.5 bar 36.25 psi			
Max working pressure Pressione massima	10 bar 145 psi			
Max working temperature Temperatura massima	60 °C 140 °F			

Screen elements - Elementi filtranti

Screen Area Area filtrante	1600 cm ² 248 in ²	2300 cm ² 357 in ²	3500 cm ² 543 in ²	5500 cm ² 853 in ²
Filtration degrees Gradi di filtrazione	1000 / 800 / 500 / 400 / 200 / 100 / 50 / 25 µm			
Screen types Tipologia elementi filtranti	Multi-layers screens: SS AISI316 + PETP (Polyester) / Pleated cartridge: PETP Rete multistrato: Inox AISI316 + Poliestere PETP / Cartuccia plissettata: Poliestere PETP			

Cleaning Cycle - Ciclo di pulizia

Cleaning cycle time Durata ciclo di pulizia	16 - 20 sec			
Min cleaning flow rate Portata minima di pulizia	6 m ³ /h 26 US gpm	9 m ³ /h 40 US gpm	9 m ³ /h 40 US gpm	15 m ³ /h 66 US gpm
Rinse water discharged Acqua di pulizia scaricata	30 L	40 L	40 L	70 L
Drain valve Valvola di scarico	1"½ F threaded			
Cleaning criteria Avvio ciclo di pulizia	Differential pressure (0.6 bar), time intervals and manual operation Pressione differenziale (0.6 bar), intervalli di tempo, manualmente			

Electrical data - Dati elettrici

Filter size Taglia filtro	All filters - tutti i filtri
Supply voltage Tensione di alimentazione	230 Vac 1-phase 50/60 Hz Optional: 400 Vac 3-phases 50/60 Hz
Control voltage Voltaggio di comando	24 Vdc
Electric motor power Potenza elettrica motore	110 W
Electric motor consumption Consumo motore elettrico	2,8 A

Materials - Materiali

Filter Body Corpo filtro	AISI 304 / AISI 316 / DUPLEX / 254 SMO
Cover Coperchio	AISI 304 / AISI 316 / DUPLEX / 254 SMO
Screen support Supporto rete	AISI 316 / DUPLEX / 254 SMO / TITANIUM
Gasket Guarnizioni	EPDM

Head loss - Perdite di carico

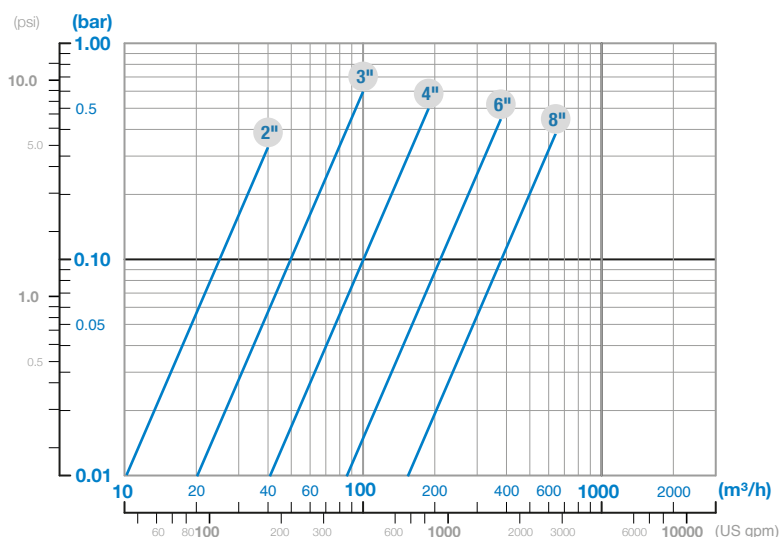

Shape H - Forma H

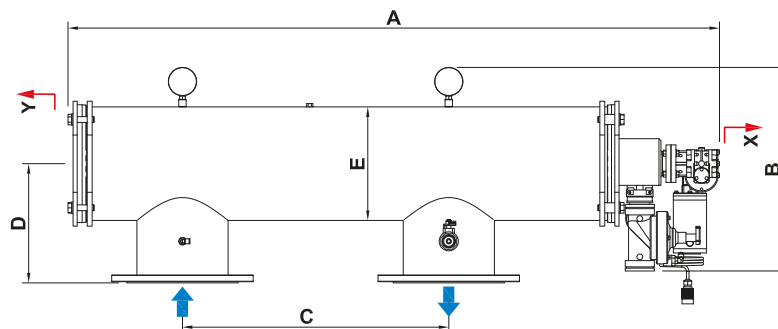

Dimensions - Dimensioni

Filter Model Modello filtro	In/Out Conn.	Drain Conn.	Filter Area [cm ²]	Max Flow rate [m ³ /h]	A [mm]	B [mm]	C [mm]	D [mm]	E [mm]	X [mm]	Y [mm]	Weight [Kg]
AVC-AVB 16H2	2" flg	1"½ thrdF	1600	30	1145	460	450	215	206	400	600	45
AVC-AVB 16H3	3" flg	1"½ thrdF	1600	60	1145	460	450	215	206	400	600	46
AVC-AVB 16H4	4" flg	1"½ thrdF	1600	100	1145	460	450	215	206	400	600	47
AVC-AVB 23H3	3" flg	1"½ thrdF	2300	60	1145	460	450	215	206	600	400	47
AVC-AVB 23H4	4" flg	1"½ thrdF	2300	100	1145	460	450	215	206	600	400	48
AVC-AVB 23H6	6" flg	1"½ thrdF	2300	180	1145	460	450	215	206	600	400	52
AVC-AVB 35H4	4" flg	1"½ thrdF	3500	100	1605	520	640	285	273	600	900	72
AVC-AVB 35H6	6" flg	1"½ thrdF	3500	220	1605	520	640	285	273	600	900	76
AVC-AVB 35H8	8" flg	1"½ thrdF	3500	270	1605	520	640	285	273	600	900	82
AVC-AVB 55H4	4" flg	1"½ thrdF	5500	100	1605	520	640	285	273	900	600	74
AVC-AVB 55H6	6" flg	1"½ thrdF	5500	220	1605	520	640	285	273	900	600	78
AVC-AVB 55H8	8" flg	1"½ thrdF	5500	390	1605	520	640	285	273	900	600	87

Shape L - Forma L

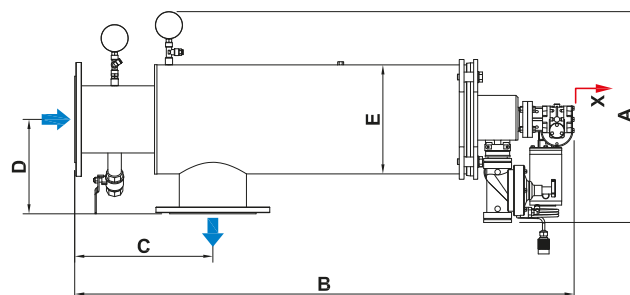

Dimensions - Dimensioni

Filter Model Modello filtro	In/Out Conn.	Drain Conn.	Filter Area [cm ²]	Max Flow rate [m ³ /h]	A [mm]	B [mm]	C [mm]	D [mm]	E [mm]	X [mm]	Weight [Kg]
AVC-AVB 16L2	2" flg	1"½ thrdF	1600	30	500	760	295	203	206	400	30
AVC-AVB 16L3	3" flg	1"½ thrdF	1600	60	500	760	295	203	206	400	31
AVC-AVB 16L4	4" flg	1"½ thrdF	1600	100	500	760	295	203	206	400	32
AVC-AVB 23L3	3" flg	1"½ thrdF	2300	60	500	930	295	203	206	600	32
AVC-AVB 23L4	4" flg	1"½ thrdF	2300	100	500	930	295	203	206	600	35
AVC-AVB 23L6	6" flg	1"½ thrdF	2300	180	500	930	295	203	206	600	38
AVC-AVB 35L4	4" flg	1"½ thrdF	3500	100	540	980	345	236	273	600	44
AVC-AVB 35L6	6" flg	1"½ thrdF	3500	220	540	980	345	236	273	600	47
AVC-AVB 35L8	8" flg	1"½ thrdF	3500	270	540	980	345	236	273	600	52
AVC-AVB 55L4	4" flg	1"½ thrdF	5500	100	540	1270	345	236	273	900	52
AVC-AVB 55L6	6" flg	1"½ thrdF	5500	220	540	1270	345	236	273	900	57
AVC-AVB 55L8	8" flg	1"½ thrdF	5500	390	540	1270	345	236	273	900	62

Shape Y - Forma Y

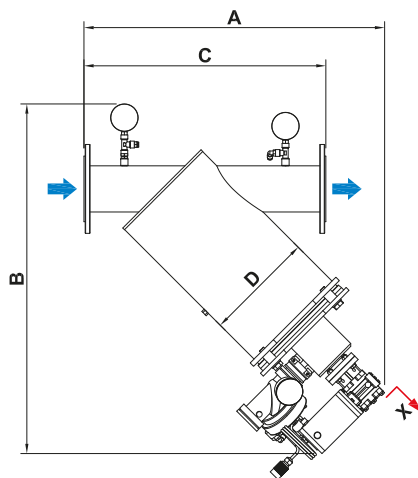

Dimensions - Dimensioni

Filter Model Modello filtro	In/Out Conn.	Drain Conn.	Filter Area [cm ²]	Max Flow rate [m ³ /h]	A [mm]	B [mm]	C [mm]	D [mm]	X [mm]	Weight [Kg]
AVC-AVB 16Y2	2" flg	1"½ thrdF	1600	30	585	745	395	206	400	30
AVC-AVB 16Y3	3" flg	1"½ thrdF	1600	60	605	765	450	206	400	31
AVC-AVB 16Y4	4" flg	1"½ thrdF	1600	100	645	475	550	206	400	32
AVC-AVB 23Y3	3" flg	1"½ thrdF	2300	60	725	875	450	206	600	32
AVC-AVB 23Y4	4" flg	1"½ thrdF	2300	100	765	885	550	206	600	35
AVC-AVB 35Y4	4" flg	1"½ thrdF	3500	100	775	895	600	273	600	44
AVC-AVB 35Y6	6" flg	1"½ thrdF	3500	220	845	925	745	273	600	47
AVC-AVB 55Y4	4" flg	1"½ thrdF	5500	100	975	1095	600	273	900	52
AVC-AVB 55Y6	6" flg	1"½ thrdF	5500	220	1045	1125	745	273	900	57

General data - Dati generali

Filter size Taglia filtro	81	110	198
Inlet/outlet diameter Diámetro connessioni IN/OUT	6" / 8" / 10" flanged EN 1092-1	8" / 10" / 12" flanged EN 1092-1	10" / 12" / 16" flanged EN 1092-1
Max flow rate (*) Portata massima	600 m ³ /h 2642 US gpm	800 m ³ /h 3522 US gpm	1400 m ³ /h 6164 US gpm
Min working pressure Pressione minima	2.5 bar 36.25 psi		
Max working pressure Pressione massima	10 bar 145 psi		
Max working temperature Temperatura massima	60 °C 140 °F		

Screen elements - Elementi filtranti

Screen Area Area filtrante	8100 cm ² 1256 in ²	11000 cm ² 1705 in ²	19800 cm ² 3069 in ²
Filtration degrees Gradi di filtrazione	2000 / 1000 / 800 / 500 / 400 / 200 / 100 / 50 / 25 µm		
Screen types Tipologia elementi filtranti	Multi-layers screens: Stainless Steel AISI 316 or SS AISI316 + PETP (Polyester) Rete multistrato: Acciaio inox AISI 316 oppure Inox AISI316 + Poliestere PETP		

Cleaning Cycle - Ciclo di pulizia

Cleaning cycle time Durata ciclo di pulizia	16 - 20 sec		
Min cleaning flow rate Portata minima di pulizia	20 m ³ /h 26 US gpm	30 m ³ /h 40 US gpm	40 m ³ /h 40 US gpm
Rinse water discharged Acqua di pulizia scaricata	70 L	100 L	130 L
Drain valve Valvola di scarico	2" flanged EN 1092-1	3" flanged EN 1092-1	3" flanged EN 1092-1
Cleaning criteria Avvio ciclo di pulizia	Differential pressure (0.6 bar), time intervals and manual operation Pressione differenziale (0.6 bar), intervalli di tempo, manualmente		

Electrical data - Dati elettrici

Filter size Taglia filtro	81	110	198
Supply voltage Tensione di alimentazione	230 Vac 1-phase 50/60 Hz Optional: 400 Vac 3-phases 50/60 Hz		
Control voltage Voltaggio di comando	24 Vdc		
Electric motor power Potenza elettrica motore	180 W	220 W	360 W

Materials - Materiali

Filter Body Corpo filtro	AISI 304 / AISI 316 / DUPLEX / 254 SMO
Cover Coperchio	AISI 304 / AISI 316 / DUPLEX / 254 SMO
Screen support Supporto rete	AISI 316 / DUPLEX / 254 SMO / TITANIUM
Gasket Guarnizioni	EPDM

Head loss - Perdite di carico

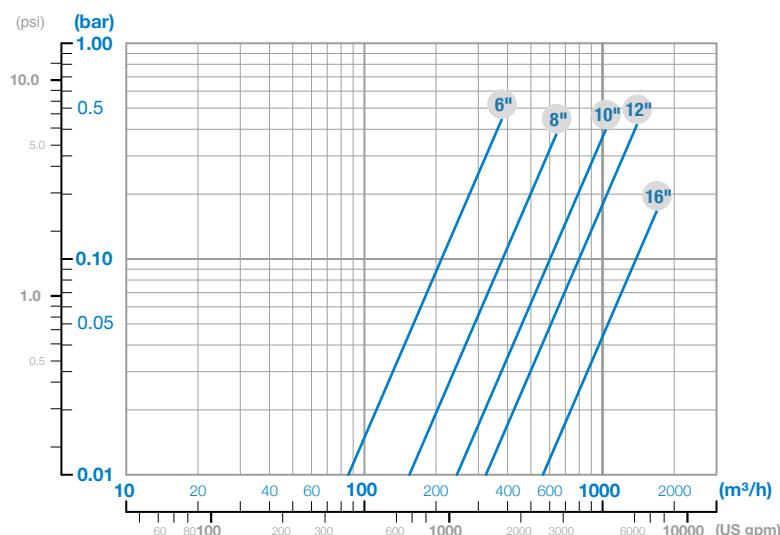

Shape H - Forma H

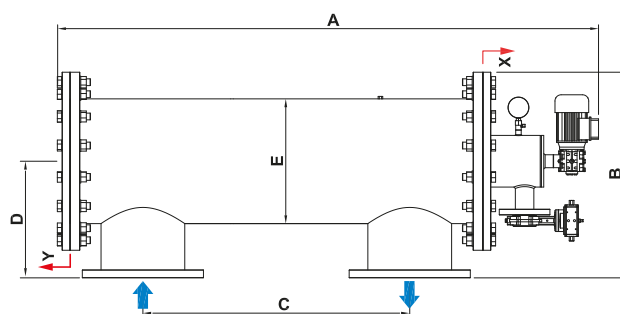

Dimensions - Dimensioni

Filter Model Modello filtro	In/Out Conn.	Drain Conn.	Filter Area [cm ²]	Max Flow rate [m ³ /h]	A [mm]	B [mm]	C [mm]	D [mm]	E [mm]	X [mm]	Y [mm]	Weight [Kg]
AVC-AVB 81H6	6" flg	2" flg	8100	220	1750	650	640	350	406	900	600	265
AVC-AVB 81H8	8" flg	2" flg	8100	390	1750	650	640	350	406	900	600	275
AVC-AVB 81H10	10" flg	2" flg	8100	600	1750	650	640	350	406	900	600	285

AVC-AVB 110H8	8" flg	3" flg	11000	390	2100	680	640	380	457	1200	600	340
AVC-AVB 110H10	10" flg	3" flg	11000	600	2100	680	640	380	457	1200	600	350
AVC-AVB 110H12	12" flg	3" flg	11000	800	2100	680	640	380	457	1200	600	355

AVC-AVB 198H10	10" flg	3" flg	19800	600	2450	850	640	460	610	1500	600	545
AVC-AVB 198H12	12" flg	3" flg	19800	800	2450	850	640	460	610	1500	600	550
AVC-AVB 198H16	16" flg	3" flg	19800	1400	2450	850	640	460	610	1500	600	585

Shape L - Forma L

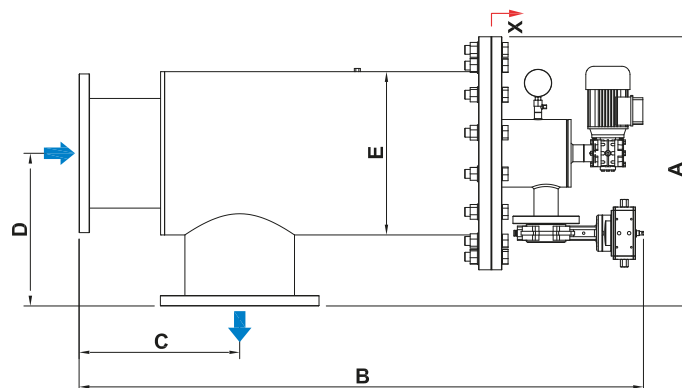

Dimensions - Dimensioni

Filter Model Modello filtro	In/Out Conn.	Drain Conn.	Filter Area [cm ²]	Max Flow rate [m ³ /h]	A [mm]	B [mm]	C [mm]	D [mm]	E [mm]	X [mm]	Weight [Kg]
AVC-AVB 81L6	6" flg	2" flg	8100	220	640	1400	400	350	406	900	170
AVC-AVB 81L8	8" flg	2" flg	8100	390	640	1400	400	350	406	900	180
AVC-AVB 81L10	10" flg	2" flg	8100	600	640	1400	400	350	406	900	190

AVC-AVB 110L8	8" flg	3" flg	11000	390	680	1700	500	380	457	1200	225
AVC-AVB 110L10	10" flg	3" flg	11000	600	680	1700	500	380	457	1200	235
AVC-AVB 110L12	12" flg	3" flg	11000	800	680	1700	500	380	457	1200	240

AVC-AVB 198L10	10" flg	3" flg	19800	600	850	2000	600	460	610	1500	340
AVC-AVB 198L12	12" flg	3" flg	19800	800	850	2000	600	460	610	1500	345
AVC-AVB 198L16	16" flg	3" flg	19800	1400	850	2000	600	460	610	1500	380

ABV filters



PSML



SSML



NO STOP FLOW



Vacuum-Brush



SHAPES

The automatic self-cleaning filter with double cleaning system. High efficiency due to the combined action of brushes and vacuum pads.



- Multi-layers screens with several filtration degrees
- No interruption flow during the cleaning cycle
- Economic and robust choice for automation of filtration
- Very simple and reliable cleaning mechanism with specialpads with brushes

Alfa Water ABV filters are automatic filters equipped with a double cleaning system, which allows the filter to be used even in the presence of coarse suspended solids. Thanks to this double system, this filter has a high cleaning efficiency: first, the brushes remove the most coarse solids from the screen, draining them through the opening of a first drain valve; then, through the opening of a second drain valve on the cover, the suction scanner effect is generated, in which the pads suck the smaller solids. ABV filters can support flow rates of up to 390 m³/h (2642 US gpm) with five sizes of screens up to 5500 cm², with several multi-layers screens covering the range of filtration degree between 1000 and 25 µm and with different range of inlet/outlet flanged connections between 2" and 8"

Available 2 controllers:

- AWC Basic controller (differential pressure and/or preset time and/or manual start, IP54, 4DI, 4AI/DI, 4DO, LCD Display 1.5")
- AWC Full controller (as AWC Basic but it can be integrated into existing systems, no need monitoring, IP54, 4DI, 4AI/DI, 4PowerDO + 3DO, LCD Display 3.5")



*Filtro automatico autopulente con doppio sistema di pulizia.
Alta efficienza dovuta all'azione combinata di spazzole e pattini aspiranti.*

- Reti multistrato con ampio range di filtrazione
- Continuità di flusso durante il ciclo di pulizia
- Scelta economica e robusta per sistemi automatici di pulizia
- Meccanismo di pulizia molto semplice e affidabile con "suction scanner"

I filtri Alfa Water ABV sono filtri automatici dotati di doppio sistema di pulizia, che permette l'utilizzo del filtro anche in presenza di solidi sospesi grossolani. Grazie a questo doppio sistema, questo filtro ha un'elevata efficienza di pulizia: prima le spazzole rimuovono i solidi più grossolani dalla rete, scaricandoli attraverso l'apertura di una prima valvola; successivamente, attraverso l'apertura di una seconda valvola posta sul coperchio, si genera l'effetto di suction scanner in cui i pattini aspirano i solidi più fini.

I filtri ABV possono trattare una portata fino a 390 m³/h (2642 US gpm) con cinque taglie di cartucce con area filtrante fino a 5500 cm², con molteplici cartucce multistrato con range di filtrazione compreso tra 1000 e 25 µm e con connessioni flangiate in ingresso e in uscita comprese tra 2" e 8".

Disponibili 2 controller:

- AWC Basic controller (differenza di pressione e/o tempi pre-impostabili e/o avvio manuale, IP54, 4DI, 4AI/DI, 4DO, Display LCD 1.5")
- AWC Full controller (stesse caratteristiche di AWC Basic con possibilità di integrazione con sistemi esistenti, nessuna necessità di monitoraggio, IP54, 4DI, 4AI/DI, 4PowerDO + 3DO, Display LCD 3.5")

General data - Dati generali

Filter size Taglia filtro	16	23	35	55
Inlet/outlet diameter Diametro connessioni IN/OUT	2" / 3" / 4" flanged EN 1092-1	3" / 4" / 6" flanged EN 1092-1	4" / 6" / 8" flanged EN 1092-1	4" / 6" / 8" flanged EN 1092-1
Max flow rate (*) Portata massima	100 m ³ /h 440 US gpm	180 m ³ /h 793 US gpm	270 m ³ /h 1189 US gpm	390 m ³ /h 1717 US gpm
Min working pressure Pressione minima	2.5 bar 36.25 psi			
Max working pressure Pressione massima	10 bar 145 psi			
Max working temperature Temperatura massima	60 °C 140 °F			

Screen elements - Elementi filtranti

Screen Area Area filtrante	1600 cm ² 248 in ²	2300 cm ² 357 in ²	3500 cm ² 543 in ²	5500 cm ² 853 in ²
Filtration degrees Gradi di filtrazione	1000 / 800 / 500 / 400 / 200 / 100 / 50 / 25 µm			
Screen types Tipologia elementi filtranti	Multi-layers screens: Stainless Steel AISI 316 or SS AISI316 + PETP (Polyester) Rete multistrato: Acciaio inox AISI 316 oppure Inox AISI316 + Poliestere PETP			

Cleaning Cycle - Ciclo di pulizia

Cleaning device Sistema di pulizia	Flexible Suction PADS with brushes - PVC material Pattini flessibili con spazzole in PVC			
Cleaning cycle time Durata ciclo di pulizia	40 sec			
Min cleaning flow rate (at 2.5 bar) Portata minima di pulizia	6 m ³ /h 26 US gpm	9 m ³ /h 40 US gpm	9 m ³ /h 40 US gpm	15 m ³ /h 66 US gpm
Rinse water discharged Acqua di pulizia scaricata	75 L	100 L	100 L	150 L
Drain valve Valvola di scarico	1"½ F threaded			
Cleaning criteria Avvio ciclo di pulizia	Differential pressure (0.6 bar), time intervals and manual operation Pressione differenziale (0.6 bar), intervalli di tempo, manualmente			

Electrical data - Dati elettrici

Supply voltage Tensione di alimentazione	230 Vac 1-phase 50/60 Hz Optional: 400 Vac 3-phases 50/60 Hz
Control voltage Voltaggio di comando	24 Vdc
Electric motor power Potenza elettrica motore	110 W
Electric motor consumption Consumo motore elettrico	2,8 A

Materials - Materiali

Filter Body Corpo filtro	AISI 304 / AISI 316 / DUPLEX / 254 SMO
Cover Coperchio	AISI 304 / AISI 316 / DUPLEX / 254 SMO
Screen support Supporto rete	AISI 316 / DUPLEX / 254 SMO / TITANIUM
Gasket Guarnizioni	EPDM

Head loss - Perdite di carico

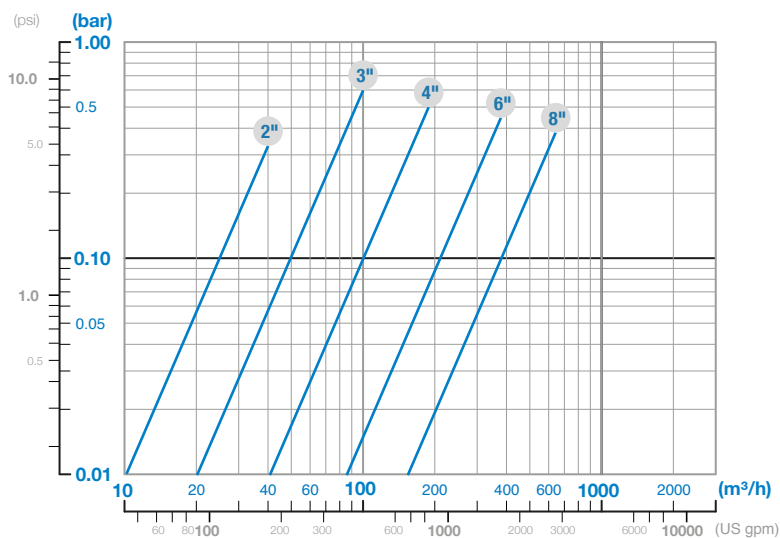

Shape H - Forma H

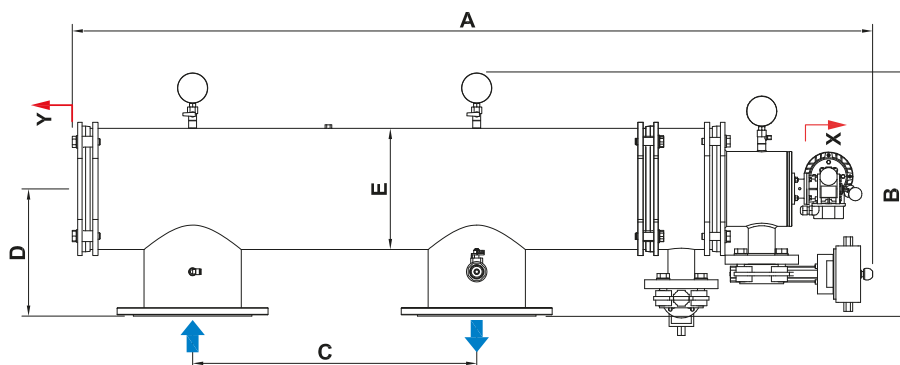

Dimensions - Dimensioni

Filter Model Modello filtro	In/Out Conn.	Drain Conn.	Filter Area [cm ²]	Max Flow rate [m ³ /h]	A [mm]	B [mm]	C [mm]	D [mm]	E [mm]	X [mm]	Y [mm]	Weight [Kg]
ABV 16H2	2" flg	1"½ flg	1600	30	1405	510	450	215	206	400	600	51
ABV 16H3	3" flg	1"½ flg	1600	60	1405	510	450	215	206	400	600	52
ABV 16H4	4" flg	1"½ flg	1600	100	1405	510	450	215	206	400	600	53

ABV 23H3	3" flg	1"½ flg	2300	60	1405	510	450	215	206	600	400	53
ABV 23H4	4" flg	1"½ flg	2300	100	1405	510	450	215	206	600	400	54
ABV 23H6	6" flg	1"½ flg	2300	180	1405	510	450	215	206	600	400	58

ABV 35H4	4" flg	2" flg	3500	100	1865	545	640	285	273	600	900	79
ABV 35H6	6" flg	2" flg	3500	220	1865	545	640	285	273	600	900	83
ABV 35H8	8" flg	2" flg	3500	270	1865	545	640	285	273	600	900	89

ABV 55H4	4" flg	2" flg	5500	100	1865	545	640	285	273	900	600	81
ABV 55H6	6" flg	2" flg	5500	220	1865	545	640	285	273	900	600	85
ABV 55H8	8" flg	2" flg	5500	390	1865	545	640	285	273	900	600	94

Shape L - Forma L

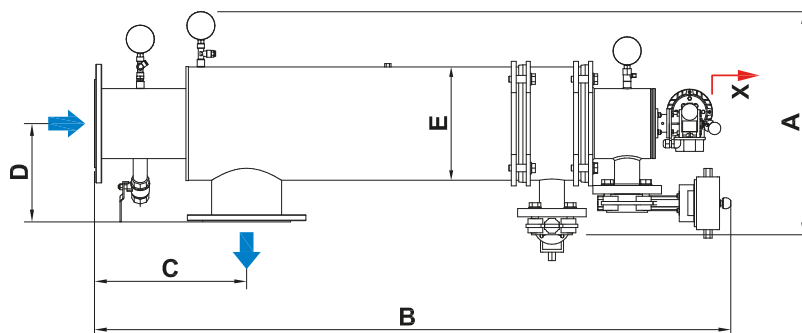

Dimensions - Dimensioni

Filter Model Modello filtro	In/Out Conn.	Drain Conn.	Filter Area [cm ²]	Max Flow rate [m ³ /h]	A [mm]	B [mm]	C [mm]	D [mm]	E [mm]	X [mm]	Weight [Kg]
ABV 16L2	2" flg	1"½ flg	1600	30	510	1020	295	203	206	400	36
ABV 16L3	3" flg	1"½ flg	1600	60	510	1020	295	203	206	400	37
ABV 16L4	4" flg	1"½ flg	1600	100	510	1020	295	203	206	400	38

ABV 23L3	3" flg	1"½ flg	2300	60	510	1190	295	203	206	600	38
ABV 23L4	4" flg	1"½ flg	2300	100	510	1190	295	203	206	600	41
ABV 23L6	6" flg	1"½ flg	2300	180	510	1190	295	203	206	600	44

ABV 35L4	4" flg	2" flg	3500	100	545	1240	345	236	273	600	51
ABV 35L6	6" flg	2" flg	3500	220	545	1240	345	236	273	600	54
ABV 35L8	8" flg	2" flg	3500	270	545	1240	345	236	273	600	59

ABV 55L4	4" flg	2" flg	5500	100	545	1530	345	236	273	900	59
ABV 55L6	6" flg	2" flg	5500	220	545	1530	345	236	273	900	64
ABV 55L8	8" flg	2" flg	5500	390	545	1530	345	236	273	900	69

AMA filters

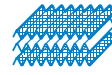

AMC



PCML



Spray nozzles



SHAPES



Microfiltration up to 1 micron with automatic cleaning.

- Plated multilayer cartridge (AMC or PCML technology) with large filter area
- Efficient cleaning with pressurized nozzles
- Multi-cartridge solution
- Available with multi-body filters for high flow rates

Alfa Water AMA filters are self-cleaning filters with automatic cleaning of AMC filter cartridges with pressurized nozzles. The filtration is from inside to the outside; the center shaft with nozzles proceeds to clean the cartridges for clogging achieved (thanks to the differential pressure switch) or at preset time, managed by a controller. An external source of pressurized clean water supplies cleaning nozzles; the drain of the washing water is by gravity.

The reinforced fiberglass body encloses up to two 20" cartridges, with a filtration range of 20 to 1 μm , and it can have 2" to 8" flanged input / output connections. All materials used are compatible with drinking water and sea water resistant.

Available 2 controllers:

- AWC Basic controller (differential pressure and/or preset time and/or manual start, IP54, 4DI, 4AI/DI, 4DO, LCD Display 1.5")
- AWC Full controller (as AWC Basic but it can be integrated into existing systems, no need monitoring, IP54, 4DI, 4AI/DI, 4PowerDO + 3DO, LCD Display 3.5")

Microfiltrazione fino a 1 micron con pulizia automatica.

- Cartuccia plissettata con supporto multistrato (tecnologia AMC o PCML) con grande area filtrante
- Pulizia efficiente con getti pressurizzati
- Soluzione multi-cartuccia
- Soluzione con filtri in parallelo per grandi portate

I filtri Alfa Water AMA sono filtri autopulenti con pulizia automatica delle cartucce filtranti AMC a ugelli pressurizzati. La filtrazione avviene dall'interno all'esterno; l'albero centrale con ugelli procede alla pulizia delle cartucce per intasamento raggiunto (grazie al pressostato differenziale) oppure a tempo preimpostato, mediante controller. Una fonte esterna di acqua pulita pressurizzata alimenta gli ugelli di pulizia; lo scarico dell'acqua di lavaggio avviene per gravità.

Il corpo in vetroresina rinforzata racchiude fino a due cartucce da 20", con un range di filtrazione tra 20 e 1 μm , e può avere connessioni di ingresso/uscita flangiate da 2" a 8".

Tutti i materiali utilizzati sono compatibili per l'acqua potabile e resistenti all'acqua di mare.

Disponibili 2 controller:

- AWC Basic controller (differenza di pressione e/o tempi pre-impostabili e/o avvio manuale, IP54, 4DI, 4AI/DI, 4DO, Display LCD 1.5")
- AWC Full controller (stesse caratteristiche di AWC Basic con possibilità di integrazione con sistemi esistenti, nessuna necessità di monitoraggio, IP54, 4DI, 4AI/DI, 4PowerDO + 3DO, Display LCD 3.5")

General data - Dati generali

Filter size Taglia filtro	100	200	300	400	500
Inlet/outlet diameter Diámetro connessioni IN/OUT	3" flanged EN 1092-1	4" flanged EN 1092-1	4" / 6" flanged EN 1092-1	4" / 6" / 8" flanged EN 1092-1	4" / 6" / 8" flanged EN 1092-1
Drain connection Connessione di drain	3" flanged EN 1092-1	4" flanged EN 1092-1			
Clean water connection Connessione acqua pulita	1"½ flanged EN 1092-1	2" flanged EN 1092-1			
Max flow rate Portata massima	60 m³/h 264 US gpm	120 m³/h 528 US gpm	180 m³/h 793 US gpm	240 m³/h 1056 US gpm	300 m³/h 1320 US gpm
Min working pressure Pressione minima	1 bar 15 psi				
Max working pressure Pressione massima	10 bar 145 psi				
Max working temperature Temperatura massima	60 °C 140 °F				

Screen elements AMC 100 - Elementi filtranti AMC 100

Max. Screen Area Area filtrante massima	10000 cm² 1550 in²
Filtration degrees Gradi di filtrazione	10 / 5 / 1 µm
Screen types Tipologia elementi filtranti	Screen: Plated PETP (Polyester) or PTFE Rete: plissetata in Poliestere PETP o PTFE

Cleaning Cycle - Ciclo di pulizia

Cleaning cycle time Durata ciclo di pulizia	200 sec	400 sec	600 sec	800 sec	1000 sec
Min cleaning flow rate (at 2.5 bar) Portata minima di pulizia	10 m³/h 44 US gpm				
Rinse water discharged (200 sec) Acqua di pulizia scaricata	400 L	800 L	1200 L	1600 L	2000 L
Pressure min. cleaning water Pressione min. acqua di lavaggio	5 bar 72 psi				
Cleaning criteria Avvio ciclo di pulizia	Differential pressure (0.6 bar), time intervals and manual operation Pressione differenziale (0.6 bar), intervalli di tempo, manualmente				

Electrical data - Dati elettrici

Filter size Taglia filtro	All filters - tutti i filtri
Supply voltage Tensione di alimentazione	230 Vac 1-phase 50/60 Hz Optional: 400 Vac 3-phases 50/60 Hz
Control voltage Votaggio di comando	24 Vdc
Electric motor power Potenza elettrica motore	110 W
Electric motor consumption Consumo motore elettrico	2,8 A

Materials - Materiali

Filter Body Corpo filtro	AISI 304 / AISI 316 / FRP
Cover Coperchio	AISI 304 / AISI 316 / FRP
Screen Elemento filtrante	PETP (Polyester) / PTFE
Gasket Guarnizioni	EPDM

Head loss - Perdite di carico

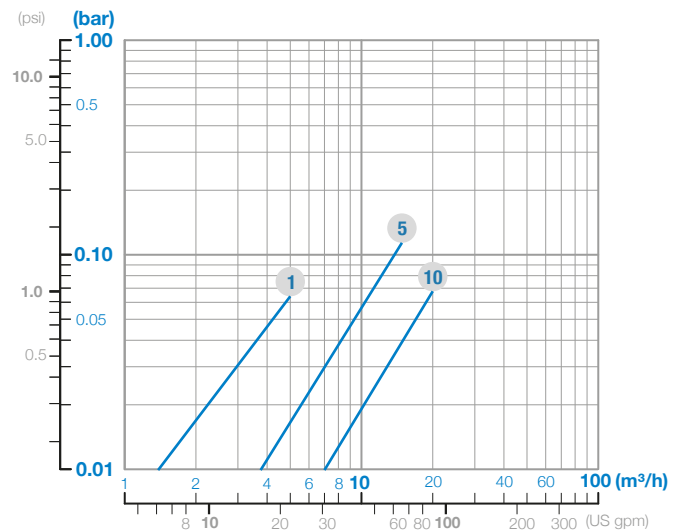

AMC PLEATED CARTRIDGE *CARTUCCIA PLISSETTATA*

The patented self-cleaning cartridges AMC are high-flow pleated cartridges with multi-layer rigid structure, that it allows the filter element to be easily cleaned. AMC pleated cartridges are used in AMA systems with a degree of filtration of 20, 10, 5 and 1 micron. The cartridges have a height of 20" and a filter surface of 22,000 cm².

Le cartucce brevettate autopulenti AMC sono cartucce plissettate a elevato flusso con struttura rigida multistrato, che consente all'elemento filtrante di essere facilmente pulito. Le cartucce plissettate AMC sono impiegate nei sistemi AMA con grado di filtrazione di 20, 10, 5 e 1 micron.

Le cartucce hanno altezza di 20" e superficie filtrante di 22.000 cm².

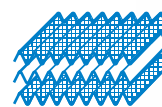

www.alfawater.it



Alfa Water Srl
Via Visome, 149
32100 Belluno (ITALY)
P .IVA: IT 01183510252
Tel. +39 0437 573039
info@alfawater.it
www.alfawater.it

